



# Foothill-De Anza Community College District



## ENERGY MASTER PLAN



**FINAL DRAFT Version 4  
September 2021**

Produced by the  
Energy and Sustainability  
Advisory Committee  
(ESAC)



## ACKNOWLEDGMENTS

### Foothill-De Anza Community College District Board of Trustees

- Peter Landsberger, President
- Patrick J. Ahrens, Vice President
- Laura Casas
- Pearl Chang
- Gilbert Wong

### Administration

- Judy C. Miner, Chancellor
- Lloyd Holmes, President, De Anza College
- Thuy Nguyen, President, Foothill College
- Susan Cheu, Vice Chancellor, Business Services
- Joel Cadiz, Executive Director, Facilities and Operations

### Energy and Sustainability Advisory Committee (ESAC)

- Co-Chair: Joel Cadiz, Executive Director, Facilities and Operations
- Co-Chair: Robert Cormia, Instructor, Chemistry, Foothill College
- Susan Cheu, Vice Chancellor, Business Services
- Tom Armstrong, Director, Capital Construction Program (retired August 2021)
- Anthony Caceres, Special Projects Coordinator
- Julie Ceballos, Writer/Editor/Web Content Developer, Marketing and Public Relations, Foothill College
- Nur Afizah Fadhilah, Chair, Environmental Sustainability, De Anza Student Government (starting June 2021)
- Pam Grey, Vice President, Administrative Services, De Anza College
- Cynthia Kaufman, Faculty Director, Vasconcellos Institute for Democracy in Action, De Anza College
- Jennifer Mahato, Director, College Operations, De Anza College
- Carla Maitland, Executive Assistant, Business Services
- Diana Martinez, Coordinator, Cheeseman Environmental Study Area, De Anza College
- Belen Simmet, Executive Assistant, Facilities and Operations
- Bret Watson, Vice President, Finance and Administrative Services, Foothill College
- Yuetong Zhang, Chair, Environmental Sustainability, De Anza Student Government (through May 2021)

### Other Plan Contributors

- Matt Sullivan PE LEED AP, Principal, Sullivan Consulting



# TABLE OF CONTENTS

<b>SECTION 1.</b>	<b>EXECUTIVE SUMMARY .....</b>	<b>1</b>
<b>SECTION 2.</b>	<b>BACKGROUND .....</b>	<b>2</b>
2.1	HISTORY OF ENERGY AND SUSTAINABILITY EFFORTS TO DATE .....	2
2.2	CREATION OF THE ENERGY MASTER PLAN .....	2
2.3	ENERGY AND SUSTAINABILITY ADVISORY COMMITTEE.....	3
2.4	THE POLICY CONTEXT OF ENERGY AND SUSTAINABILITY PLANNING .....	3
<b>SECTION 3.</b>	<b>MISSION STATEMENT, GOALS, AND OBJECTIVES .....</b>	<b>6</b>
3.1	EMP PLANNING STRUCTURE .....	6
3.2	MISSION STATEMENT.....	7
3.3	ENERGY MASTER PLAN GOALS.....	7
3.4	OBJECTIVES.....	8
<b>SECTION 4.</b>	<b>PROGRAMS AND PROJECTS FOR IMPLEMENTATION .....</b>	<b>10</b>
4.1	MANAGEMENT AND ORGANIZATIONAL STRUCTURE .....	10
4.2	CARBON REDUCTION GOALS.....	11
4.3	ENERGY EFFICIENCY.....	13
4.4	FACILITIES OPERATION .....	15
4.5	SUSTAINABLE BUILDING PRACTICES .....	18
4.6	ON-SITE GENERATION AND RENEWABLE ENERGY.....	20
4.7	TRANSPORTATION, COMMUTING, AND CAMPUS FLEET & TRAVEL .....	22
4.8	STUDENT AND CURRICULUM DEVELOPMENT .....	22
4.9	CAMPUS AND COMMUNITY OUTREACH & AWARENESS.....	23
<b>SECTION 5.</b>	<b>MEASURE AND REPORT PERFORMANCE .....</b>	<b>25</b>
5.1	MEASURING PERFORMANCE .....	25
5.2	REPORTING PERFORMANCE.....	25
<b>SECTION 6.</b>	<b>APPENDICES .....</b>	<b>28</b>
	APPENDIX A – DISTRICT PROPOSITION 39 PROJECTS, 2013-2019	
	APPENDIX B – IMPLEMENTATION PROGRAMS AND PLANS CHECKLIST	
	APPENDIX C – EMP GANTT CHART SCHEDULE	
	APPENDIX D – MEASURE G BOND ENERGY-SAVING PROJECTS	
	APPENDIX E – TOTEM ANALYSIS WHITE PAPER	
	APPENDIX F – 2021 BENCHMARKING STUDY RESULTS	
	APPENDIX G – GLOSSARY OF TERMS	



## SECTION 1. EXECUTIVE SUMMARY

As with many public sector agencies, the Foothill-De Anza Community College District recognizes the environmental, economic, and social equity benefits of resource efficiency and sustainability. The passage of the California Global Warming Solutions Act (AB-32), subsequent legislation and Executive Orders requiring carbon reduction, and the adoption of the 2019 California Community Colleges Board of Governors' Climate Change and Sustainability Policy have made it imperative for California community colleges to act. Additionally, the UN Intergovernmental Panel on Climate Change (IPCC) Sixth Assessment Report issued Aug. 9, 2021 could not be clearer about the use of fossil fuels, climate change, and the narrow window of one decade to take action. This Energy Master Plan is an organized and comprehensive approach that incorporates energy efficiency and sustainability elements, addresses state regulations, and leverages available resources and complementary programs. It also prepares the district for significant decarbonization during the decade of 2020-2030.

Sustainability can be defined as "meeting the needs of the present without compromising the ability of future generations to meet their own needs." This plan aims to prepare the Foothill-De Anza district for the environmental and regulatory challenges of the 21st century, guide the district toward a more sustainable future, and prepare students for a green economy.

The Foothill-De Anza district includes Foothill College in Los Altos Hills, De Anza College in Cupertino, and the Foothill College Sunnyvale Center. The district has prepared this plan to encompass the entire district's goals and priorities.

The following plan articulates the district's mission, goals, and objectives for energy sustainability and the implementation strategies to meet these goals. The Foothill-De Anza district's Energy and Sustainability Advisory Committee (ESAC), with a membership of students, faculty members, administrators and classified professionals, has developed the plan in coordination with the many different campus stakeholders using a shared governance approach to ensure that the plan meets the diverse needs of the various campus communities.

### Energy Master Plan Mission Statement

*The Mission of the Energy and Sustainability Advisory Committee (ESAC) is to encourage energy efficiency, reduce greenhouse gas (GHG) emissions, and collaboratively advance sustainability across the Foothill-De Anza Community College District, with a commitment for educational opportunities and inclusion of students, staff, and faculty in our solutions for environmental, economic, and social sustainability.*

## SECTION 2. BACKGROUND

### 2.1 HISTORY OF ENERGY AND SUSTAINABILITY EFFORTS TO DATE

The Foothill-De Anza Community College District has been proactive in energy efficiency and sustainability for many years. Starting in 2007 and 2008, Foothill and De Anza College campuses established Sustainability Committees to plan and implement various energy and sustainability programs and projects. The Board of Trustees has established policies for district sustainability that have been incorporated into the 2010 District Sustainability Plan, the 2016 Facilities Master Plan, the 2017-2023 District Strategic Plan, and the 2018 Foothill College Sustainability Management Plan. In addition, the district has been active in recycling efforts, encourages public transit use for students and employees, implements energy and water-saving projects, and pursues efficient new construction of campus facilities, cogeneration, and solar photovoltaic power generation. Students have also been very active through the De Anza Student Government (formerly the De Anza Associated Student Body) Environmental Sustainability Committee, the Foothill College Sustainability Committee, and the current district-wide Energy and Sustainability Advisory Committee. The district was one of the earliest institutions to divest from fossil fuel investments in 2013.

The district also took full advantage of the funding provided by Proposition 39, the California Clean Energy Jobs Act of 2012, to plan and install \$2,386,191 of energy projects between 2013 and 2019. These projects save 418,726 kWh and 82,886 therms annually, with energy cost savings to the district of \$108,444 each year. These energy savings also translate to over 1.6 million pounds of avoided CO<sub>2</sub> emissions annually. Proposition 39 was a very successful program for the district. Details of projects installed, Proposition 39 funding, project costs, and energy savings are listed in Appendix A.

While the district has made significant progress on the path to sustainability, it is poised to accomplish much more with the passage of the 2020 Measure G \$898 million bond program and implementation of this Energy Master Plan.

### 2.2 CREATION OF THE ENERGY MASTER PLAN

To create this Energy Master Plan, the Energy and Sustainability Advisory Committee followed the California Community Colleges Sustainability Planning Template process. The template was created by a collaboration of the state Chancellor's Office, Citrus Community College District, the California Energy Commission, and consulting firm Newcomb Anderson McCormick. It was developed in 2011 and successfully used in early 2012 at Citrus College to develop a campus-specific Sustainability Plan. Since that time, many other community college districts have used the same template to establish energy and sustainability plans. It is designed to assist colleges





with setting goals, objectives, timelines and criteria for success. It highlights the best practices of other community colleges to develop robust, yet flexible plans tailored to each district and campus. Districts and campuses can use the template to prioritize their efforts based on college-specific goals and objectives, areas of interest, capabilities and available resources. In addition, the template provides tools for the development of action plans to achieve sustainability and measure program implementation results. Above all, the process is intended to be inclusive and collaborative and involve college students, faculty and staff in its implementation. The previous flow chart illustrates the template planning process.

## 2.3 ENERGY AND SUSTAINABILITY ADVISORY COMMITTEE

The Energy and Sustainability Advisory Committee (ESAC) was established to share timely, relevant, and accurate local and state energy and sustainability information with constituency representatives and provide a forum for identifying opportunities to promote environmental sustainability. The committee consists of students, faculty members, classified professionals and administrators, representing various district stakeholder groups. The plan was developed using the district shared governance process and the committee regularly updated various student, faculty and facilities committees to describe the progress and gain feedback during the planning process.

The acknowledgements page of the Energy Master Plan lists the ESAC membership. The Committee's co-chairs are Joel Cadiz, Executive Director of Facilities and Operations and Robert Cormia, Instructor, Chemistry at Foothill College.

## 2.4 THE POLICY CONTEXT OF ENERGY AND SUSTAINABILITY PLANNING

Sustainability can provide environmental, economic, and social benefits to campuses. However, there are other motivations for the district to pursue these practices. The state of California has been at the forefront of efforts to establish aggressive policies and standards for environmental protection and reduce greenhouse gas (GHG) emissions that contribute to global warming. In 1970, the state adopted the California Environmental Quality Act (CEQA), intending to inform governments and the public about the potential environmental impacts of projects. Since that time, the state has accelerated these policies through several executive orders and legislation to decarbonize the energy system. From 2005 onward, legislation has been passed to directly regulate GHG emissions by utilizing incentive mechanisms, cap-and-trade programs, and mandatory reporting while encouraging voluntary activities such as purchasing emissions offsets and offering renewable energy certificates (RECs). Compliance with state policies and regulations regarding these issues is an essential factor for consideration by the district.



The following paragraphs describe the numerous policy and regulatory drivers that led to the creation of this plan.

### 2.4.1 2019 Board of Governors Climate Change and Sustainability Policy

In June of 2019, the California Community Colleges Board of Governors adopted a Climate Change and Sustainability Policy to guide the community college system to comply with the various California regulations related to environmental protection. It sets goals for reducing GHG emissions, renewable energy, zero-emissions vehicles, Zero Net Energy (ZNE) buildings, green building standards, sustainable purchasing practices, and solid

waste reduction. A ZNE building is an energy-efficient building where, on a source energy basis, the actual annual delivered energy is less than or equal to the on-site renewable exported energy.

In early 2020, the State Chancellor's Office established a Climate Change Steering Committee made up of district and Chancellor's Office personnel to guide districts on complying with the policy. An updated policy framework was developed in mid-2021 by the Steering Committee strengthening sustainability targets and incorporating social justice and student learning goals. The Board of Governors will review the updated policy framework in fall 2021, and if adopted, the district will review the Energy Master Plan and update accordingly

#### ***2.4.2 California State Climate Regulations***

The State of California has been very aggressive over the past 40 years in establishing legislation and executive orders to improve energy efficiency and reduce GHG emissions. These efforts have accelerated in the past 10 years as the effects of climate change have become more prevalent resulting in the need to mitigate the impact on future generations. The following is a summary of the most critical recent state actions.

##### ***2.4.2.1 Global Warming Solutions Act of 2006 (AB 32)***

The Global Warming Solutions Act, or Assembly Bill 32 (AB 32), was adopted in 2006 by the California Legislature, establishing two critical requirements regarding climate change reduction. The first requires that California GHG emissions are capped at 1990 levels by 2020. The second establishes an enforcement mechanism for the GHG emissions reduction program with monitoring and reporting implemented by the California Air Resources Board (CARB). In 2008, the CARB released the AB 32 Scoping Plan, which describes measures to implement the requirements set by the legislation. In addition to partnering with local governments to encourage the establishment of regional emission reduction goals and community regulations, the scoping plan uses various mechanisms to reduce emissions statewide, including incentives, direct regulation, and compliance mechanisms.

In 2017, CARB updated the scoping plan to reflect state policy of reducing GHG emissions by 40% below 1990 levels by 2030. The 2017 Scoping Plan Update was the basis for the 2019 CCC Board of Governors Climate Change and Sustainability Policy. CARB is currently working on a 2022 Scoping Plan Update, which will assess progress towards achieving the 2030 target and lay out a path to achieve carbon neutrality by mid-century.

##### ***2.4.2.2 Clean Energy and Pollution Reduction Act of 2015 (SB 350)***

This bill required that the amount of electricity generated and sold to retail customers per year from eligible renewable energy resources (known as the Renewable Portfolio Standard (RPS) be increased from 33% to 50% by December 31, 2030. It also required the California Energy Commission (CEC) to establish annual targets for statewide energy efficiency savings and demand reduction to achieve a cumulative doubling of statewide energy efficiency savings in electricity and natural gas by January 1, 2030. This bill was authored by State Senator Kevin De León and enacted in 2015.

##### ***2.4.2.3 Executive Order B-18-12***

Executive Order B-18-12, signed by Governor Brown on April 25, 2012, required 50% of new state buildings beginning design after 2020 be Zero Net Energy (ZNE) and that all new buildings and major renovations beginning

design after 2025 be constructed ZNE. It also required state agencies to achieve ZNE for 50% of the square footage of the existing state-owned building area by 2025.

#### *2.4.2.4 Executive Order B-55-18 (Carbon Neutrality by 2045)*

Executive Order B-55-18, signed by Governor Brown on September 10, 2018, established a new statewide goal to achieve carbon neutrality as soon as possible, but no later than 2045, and achieve and maintain net negative emissions after that. This goal was in addition to then-existing statewide goals for the reduction of greenhouse gas emissions.

#### *2.4.2.5 100% Carbon-Free Energy by 2045 (SB 100)*

SB 100 set a 2045 goal of powering all retail electricity sold in California and state agency electricity needs with renewable and zero-carbon resources — those such as solar and wind energy that do not emit climate-altering greenhouse gases. It updated the state’s Renewables Portfolio Standard (RPS) goal to ensure that by 2030 at least 60% of California’s electricity is generated from renewable sources. It required the California Energy Commission (CEC), the California Public Utilities Commission (CPUC), and California Air Resources Board (CARB) to use programs under existing laws to achieve 100% clean electricity and issue a joint policy report on SB 100 by 2021 and every four years after that. The legislation was authored by State Senator Kevin De León and enacted in 2018.

## SECTION 3. MISSION STATEMENT, GOALS, AND OBJECTIVES

The Foothill-De Anza Community College District Energy and Sustainability Advisory Committee, utilizing the California Community Colleges Sustainability Planning Template process, established the mission, goals and objectives for the Energy Master Plan. This was accomplished through facilitated committee workshops and shared governance presentations to obtain maximum stakeholder input. After their adoption, the ESAC identified the implementation programs and projects to make the mission, goals and objectives a reality. It should be noted that while the Energy Master Plan is focused on facility energy usage the district plans to address broader sustainability issues with a follow up comprehensive Sustainability Plan in 2022.

### 3.1 EMP PLANNING STRUCTURE

The ESAC developed a planning structure designed as an inclusive, logical, comprehensive, and streamlined approach for creating the Energy Master Plan (EMP). The illustration below details this process.



The approach taken starts with a broad mission statement that captures in one sentence what the district would like to achieve with the Energy Master Plan. The next level of planning detail was articulating goals that provide broad, brief statements of intent that provide focus for planning. Next are objectives that are the “steppingstones” toward achieving the goals using the SMART process: Specific, Measurable, Achievable, Realistic, and Time-Bound. Finally, detailed implementation programs and projects were developed as the specific actions to be taken to implement the plan.

### 3.2 MISSION STATEMENT

The ESAC developed the following mission statement to guide the district in its Energy Master Planning efforts.

---

*The mission of the Energy and Sustainability Advisory Committee (ESAC) is to encourage energy efficiency, reduce greenhouse gas (GHG) emissions, and collaboratively advance sustainability across the Foothill-De Anza Community College District, with a commitment for educational opportunities and inclusion of students, staff, and faculty in our solutions for environmental, economic, and social sustainability.*

---

### 3.3 ENERGY MASTER PLAN GOALS

To realize the mission statement, the ESAC then defined the following energy and sustainability goals for the EMP.

Table 1 – Energy Master Plan Goals

Goal No.	Description
1	Develop an Energy and Sustainability Master Plan to identify measures to improve energy performance, facilitate a path to reduce greenhouse gas (GHG) emissions, and strengthen campus resilience employing all appropriate funding sources and integrating projects from the Measure G Bond program.
2	Establish an inclusionary process where students, faculty, and staff play a meaningful role in district sustainability efforts and understand the environmental, societal, and economic impacts of energy use while integrating these activities as learning opportunities to fulfill our responsibility as a higher education institution.
3	Establish objectives, criteria, and implementation plans to achieve carbon neutrality and monitor progress over time to ensure they are achieved.
4	Support state and federal energy policies and greenhouse gas (GHG) reduction goals, including the 2019 California Community Colleges Board of Governors Climate Change and Sustainability Policy.
5	Establish the Foothill-De Anza Community College District as a model of sustainability to face the challenges of the 21st century.

### 3.4 OBJECTIVES

Based on the mission and goals, the ESAC developed the following Energy Master Plan SMART Objectives providing specific, measurable, achievable, realistic, and time-bound priorities for completing the Energy Master Plan. The objectives for the EMP also reflect district needs, interests, and available resources.

**Table 2 – Energy Master Plan Objectives**

Objective	Description	Timeline
1	<b>District Carbon Reduction Goals <sup>(1)</sup></b> <ul style="list-style-type: none"> <li>• Reduce GHG emissions 50% from 2005 levels by 2030</li> <li>• Transition to natural gas-free by 2035</li> <li>• Purchased electricity will be 100% renewable by 2045 (SB 100)</li> <li>• Carbon Neutrality by 2045 (EO B-55-18)</li> </ul>	2025-2045
2	Deploy EV charging infrastructure consistent with state of California goals and timelines for electrification of transportation	2025-2030
3	Reduce Vehicle Miles Traveled (VMT) for students, faculty and staff by 25-50% by 2035 by coordinating with other ongoing district programs	2035
4	Evaluate campus resiliency opportunities	2022-2025
5	Investigate most effective ways to institutionalize energy and sustainability management in district operations	2022-2025
6	Develop processes to engage students, faculty and staff in energy and sustainability activities in a meaningful way	2021
7	Encourage and facilitate student learning activities related to energy and carbon reduction	2022
8	Enhance campus and community engagement	2022
9	Ensure activities consider broader economic and environmental impacts	Ongoing

(1) Scope 1 and Scope 2 emissions only. See Appendix G, Glossary, for definitions

The objectives described on the previous page will apply to all district facilities, including Foothill College, De Anza College, the Sunnyvale Center, and the district office facilities. The objectives are not necessarily listed by priority. The ESAC will monitor progress toward achieving the objectives during plan implementation as described in Section 5, “Measure and Report Performance.”

## SECTION 4. PROGRAMS AND PROJECTS FOR IMPLEMENTATION

Based on the goals and objectives described earlier, the Energy and Sustainability Advisory Committee has identified the following programs and projects to actively improve campus energy efficiency, sustainability and reduce GHG emissions. These programs and projects are also reflected in the Implementation Programs and Plans Checklist, located in Appendix B, which outlines program details, priorities, responsibility for implementation, and the timeline for completion. In addition, a detailed Gantt Chart Schedule was developed to illustrate the task durations and relationships (predecessor/successor) as a straightforward planning tool for the implementation of the programs and projects. The Gantt Chart Schedule can be seen in Appendix C of the EMP. The ESAC will use the checklist and schedule to manage the implementation process.

### 4.1 MANAGEMENT AND ORGANIZATIONAL STRUCTURE

To effectively implement the Energy Master Plan, it will be necessary for the Foothill-De Anza district to have a policy mandate for energy efficiency and sustainability, the institutional structure required to manage the process, the financial resources, and programmatic expertise to accomplish plan goals. The district has or plans to implement the following programs to meet this requirement.

#### 4.1.1 Adopt a District Sustainability Policy

As described earlier, the Foothill-De Anza Community College District has been proactive in energy efficiency and sustainability policy for many years. The Board of Trustees has established policies for district sustainability that have been incorporated into the 2010 District Sustainability Plan, the 2016 Facilities Master Plan, the 2017-2023 District Strategic Plan, and the 2018 Foothill College Sustainability Management Plan. In addition, the board endorsed the creation of this Energy Master Plan, which addresses districtwide and site-specific needs for each college in terms of energy and sustainability.

*Programs and projects are also listed in the Implementation Programs and Plans Checklist (Appendix B), which outlines program details, priorities, responsibility for implementation, and the timeline for completion. In addition, a detailed Gantt Chart Schedule (Appendix C) has been developed that illustrates task durations and relationships (predecessor/successor) as a straightforward planning tool for the implementation of the programs and projects.*



#### ***4.1.2 Appoint a District Energy and Sustainability Committee***

The Board of Trustees established the district Energy and Sustainability Advisory Committee (ESAC) to share timely, relevant and accurate local and state energy and sustainability information with constituency representatives, and to provide a forum for participation in defining opportunities to promote environmental sustainability. The ESAC is an advisory body and part of the district shared governance process. The role and responsibilities of the ESAC include:

- Review and make recommendations to promote environmental sustainability
- Review and make recommendations on energy and emissions resources
- Look outward/forward on strategic planning to promote environmental sustainability
- Communicate and disseminate reports and updates to respective constituency groups and the community through Board of Trustees meetings

In addition, the ESAC has been tasked by the board to manage the Energy Master Plan development and implementation.

#### ***4.1.3 Investigate the Most Effective ways to Institutionalize Energy and Sustainability Management***

The district recognizes that it is essential to institutionalize energy and sustainability into planning activities and everyday operations. Temporary, one-off efforts to manage sustainability activities will result in short-term solutions that make it difficult to maintain progress into the future. To avoid these common downfalls, the ESAC will investigate the most effective ways and best practices to incorporate sustainability into the organization and foster a culture of sustainability in district operations.

#### ***4.1.4 Participate in CCC Systemwide Energy and Sustainability Committees***

The California Community Colleges system, led by the state Chancellor's Office, has established several shared governance committees to develop and implement best practice energy and sustainability policies and programs and integrate them into district operations statewide. These committees generally consist of Chancellor's Office and district personnel who participate in regular meetings and workshops that focus on college facility and finance issues, including energy efficiency and sustainability. These committees include the Chancellor's Office Climate Policy Steering Committee, the Association of Chief Business Officers (ACBO) Facilities Task Force, and the Community Colleges Facilities Coalition (CCFC) Board of Directors.

The Foothill-De Anza district already participates in the ACBO Facilities Task Force but will broaden its activities and membership to the other committees to help evaluate and implement policy and to bring its own experiences and expertise to help influence future energy and sustainability efforts at systemwide level.

## **4.2 CARBON REDUCTION GOALS**

One of the district's highest priorities is to reduce greenhouse gas (GHG) emissions from operations, with an ultimate goal of achieving carbon neutrality to mitigate climate change. The district will undertake the following activities to achieve its carbon reduction goals. These efforts will support state of California policy goals for GHG reduction and will establish the Foothill-De Anza Community College District as a leader in energy efficiency and

sustainability among community colleges statewide.

#### **4.2.1 Implement Measure G Bond Projects**

On March 3, 2020, voters in the Foothill-De Anza Community College District's service area approved by a 58.88% margin an \$898 million general obligation measure (Measure G) to upgrade facilities preparing veterans and other for university transfer and careers in fields such as health care, nursing, technology, engineering and sciences; to upgrade and repair aging classrooms as well as labs for science, technology, engineering and math-related fields of instruction; and to acquire, construct, repair facilities, equipment and sites. The Measure G implementation plan includes many energy-saving and GHG reduction projects at each district location. The projects include new facility construction, major renovations of existing facilities, and energy-saving retrofits for existing lighting, HVAC, and central plant systems. They will significantly improve energy performance in the district and be an essential element in achieving carbon neutrality goals.

The complete list of Measure G energy-saving projects is included in Appendix D of the Energy Master Plan.

#### **4.2.2 Perform Feasibility Study for District Electrification**

As one of its first steps in implementing the EMP, the committee recommends engaging a qualified energy consultant and conducting a feasibility study to electrify facilities operations to eliminate natural gas systems, such as HVAC and hot water equipment, to achieve carbon neutrality. This study would evaluate the most effective technologies to replace existing natural gas equipment with electrically powered equipment, such as electric heat pumps and thermal energy storage. The study would also assess the necessary campus electric infrastructure upgrades to support electrification and any PG&E service changes needed. An analysis of electrification costs, potential funding sources (including Measure G funds), energy savings, emissions reductions, and return on district investment and a set of recommendations would become a road map for the district to achieve carbon neutrality.



#### **4.2.3 Quantify FY 2020-2021 FHDA energy usage and GHG emissions (Scope 1 and Scope 2)**

The COVID-19 pandemic resulted in the virtual shutdown of district campuses, and with essentially no students or staff present, there was a significant reduction of energy use at the facilities. The ESAC decided that a more appropriate baseline for energy and emissions reduction measurement would be the calendar years 2018 and 2019. However, the district will evaluate and quantify energy usage and Scope 1 and Scope 2 GHG emissions from fiscal year 2020-2021 as a reference point in the future. It will compare this to emissions in 2022 and beyond.

#### 4.2.4 TOTEM Analysis of Building 7400 (Central Energy Facility) at Foothill College

In 2019, Foothill College partnered with utility Électricité de France (EDF) Innovation Labs in Los Altos, California and San Francisco State University to evaluate the replacement of natural gas hot water boilers with a thermal microgrid (electric heat pumps and heat recovery systems) at the Central Energy Facility on campus. This analysis, using TOTEM (Tool for Optimization of Thermal and Electric Microgrids), will model the campus combined electric (power and energy) and thermal (HVAC) system to understand and evaluate thermal microgrid replacement of the natural gas uses. A TOTEM Analysis White Paper describing this project in detail can be found in Appendix E of the EMP.

The project follows in the footsteps of the Stanford Energy Systems Innovation (SESI) program, which began at Stanford University in 2009-2011 and was the first large-scale heat recovery system of its kind on a large academic campus. The SESI system replaces a complex natural gas thermal system comprising a 25-year-old combined-cycle cogeneration system and traditional thermal boilers and mechanical HVAC systems. SESI is a centralized heat recovery system with a direct substation connection to the power grid. The SESI system provides energy to the entire Stanford campus, has reduced carbon emissions by two-thirds since 2017, and will reduce more than 80% by 2025. As an early adopter of a thermal microgrid, these transformative projects can be a model for the California Community Colleges system and help form the collective leadership in deep decarbonization.

The district plans to perform the TOTEM analysis of Foothill College in parallel with the Electrification Feasibility Study. A thermal microgrid may be employed at both campuses to reduce carbon emissions and this analysis will likely inform its electrification recommendations.

### 4.3 ENERGY EFFICIENCY

Energy efficiency is the most cost-effective way to reduce campus energy use and its carbon footprint. When appropriately implemented, efficiency measures can decrease energy use without compromising comfort, improve indoor air quality, and enhance student, faculty, and staff performance. Energy efficiency will be a higher priority than renewable or other on-site energy generation due to more favorable economics and the need to avoid over-sizing renewable energy systems.

The following energy efficiency programs and projects either have already or are anticipated to be implemented at the district. This would include the energy efficiency projects projected for funding by Measure G and identified in Appendix D.

#### 4.3.1 Set Energy Efficiency Goals

Planning for energy conservation is a district priority. It is essential to set goals for the reduction of any resource to define success. As such, the district performed an energy benchmarking study in 2021 employing the US EPA Portfolio Manager software to establish energy usage and GHG emission baselines. Using this data, the district can develop annual energy use and GHG emission reduction goals and plan appropriate energy-efficiency, demand reduction, or clean self-generation measures to achieve these goals. The results of the benchmarking study can be found in Appendix F of the Energy Master Plan.

#### ***4.3.2 Evaluate Mechanisms for the Implementation of Energy Efficiency Projects***

The district can evaluate various mechanisms for identifying and implementing energy efficiency projects and programs, including the use of in-house staff, engineering consultants, design-build contractors, and energy service companies (ESCOs). The district has extensive experience with these various mechanisms for energy project delivery and can leverage this knowledge to implement the Energy Master Plan. In addition, the district will evaluate best practices provided by other California community college districts for delivering energy projects.



#### ***4.3.3 Conduct Facility Prioritization Surveys***

Conducting a Facility Prioritization Survey to identify and prioritize buildings for efficiency measures is a suggested first step. Priorities are typically based on energy use intensity (EUI) - electricity and natural gas use per gross square foot per year - with buildings with the highest energy use intensity given the highest priority. The district is planning on installing meters at the building level, which can be used to benchmark energy use. Where metered data does not exist, those buildings that are determined to be high energy users based on experience by college staff will be targeted first.

#### ***4.3.4 Conduct Comprehensive Facility Energy Audits***

Based on the Facility Prioritization Survey, the committee suggests the district engage an energy consultant to conduct ASHRAE Level 3 Energy Audits (Investment Grade Audit) at those facilities to identify projects, project costs, energy savings, and return on investment. The consultant would develop an audit report with recommendations for which projects best meet the goals of the district. Energy audits can also be enhanced by using energy models that forecast the energy performance of retrofitted or renovated facilities to provide more certainty of project outcomes.

#### ***4.3.5 Implement New and Existing Audit Recommendations***

Based upon the audits and available resources, the district should initiate implementation of the audit recommendations. Priorities will be determined by potential energy savings, return on investment, and available resources.

#### ***4.3.6 Participate in Demand Response Programs***

The district should evaluate participating in utility demand response programs to voluntarily reduce campus loads during high usage peak periods and receive incentives as a result. The district will meet with PG&E to explore the program to determine if participating is in the colleges' best interest.

#### **4.3.7 Perform a Project Funding Study**

The district should evaluate the best mechanisms to fund and finance energy projects identified in the Energy Master Plan. The study will include an analysis of the Measure G bond program to determine what funding is allowable for energy projects.

#### **4.3.8 Install Energy Efficient Equipment**

All equipment replacements identified in the EMP should be as energy efficient as feasible and will be included as performance specifications in procurement documents. This includes lighting, HVAC (including electrification measures), pumping, motors, and other equipment and systems.

#### **4.3.9 Manage Plug Loads**

Plug loads refer to energy used by equipment that is plugged into an electrical outlet. In a typical office, plug loads include computers, monitors, printers and copiers. Plug loads can average approximately 30% of electricity use in office settings, much of which can be attributed to parasitic loads (or the power draw of a plug-load that is not performing useful work). Reducing or managing plug loads is often overlooked when planning energy efficiency measures in facilities. The district should evaluate plug load management strategies, including manual control, automatic controllers, timers, occupancy sensors, load sensing controllers, and other measures.

### **4.4 FACILITIES OPERATION**

In addition to installing energy-efficient equipment, the district will strive to operate high-performing facilities, buildings, and energy infrastructure systems that are optimized for inhabitant comfort, productivity, and energy and resource efficiency. The following programs and projects either have already or will be evaluated for implementation at the district.

#### **4.4.1 Encourage and Support Energy Efficiency Training of Staff**

The engineering, maintenance, and operations staff at Foothill and De Anza colleges have been trained to operate energy-consuming equipment and systems efficiently. Further, ongoing training programs should be developed and implemented to ensure that the staff is up-to-date on equipment, mechanical and electrical systems, and operational changes in the facilities. This will be especially important as the district transitions to a carbon-free operating environment with the associated sophisticated systems in place to enable this.

#### **4.4.2 Evaluate Existing Energy Management Systems**

The district has contracted with Gridium to use the Snapmeter Energy Information System (EIS) at both college campuses and the Sunnyvale Center to monitor and track energy usage, evaluate trends in use over time, and develop analytic metrics to assist in managing and reducing energy usage. Currently, the system monitors both electricity and natural gas through 34 meters installed across all three sites connected to campus load, solar photovoltaic net generation output meters (NGOM), cogeneration systems, and a few distinct buildings on the campuses. One of the district's goals is to install whole-building meters at all campuses facilities to benchmark individual buildings and troubleshoot high energy users for mitigation strategies to reduce usage. In addition,

many of the existing meters are currently nonfunctional and will need to be repaired or replaced to provide accurate data for analysis.

The district employs Pordis Consulting and Design Services to analyze energy usage data obtained through a network of NGOMs (Net Generation Output Meters) and other submetering equipment. Gridium monitors energy consumption and provides recommendations for changes in operations and equipment to improve energy performance and reduce costs. This has been a helpful service to the district and should be evaluated for future needs, especially creating an integrated energy dashboard.

The purpose of this task will be to evaluate the effectiveness of the existing Gridium Energy Information System and whether a more sophisticated EIS/EMS system should be installed to manage energy use more effectively.

#### ***4.4.3 Adjust Temperature Set Points and Schedule Operating Times***

The district can avoid overcooling and overheating by raising cooling temperature set points and lowering heating temperature set points. For the campus Central Plants, implementing hot water reset controls with setpoint changes would help avoid wasting energy during milder weather.

A good guideline is to heat buildings at or below 68°F and cool buildings at or above 72°F to avoid excessive heating and cooling. To avoid unnecessary heat loss, domestic hot water temperatures should not be set above 120°F. These limits will not apply in areas where other temperature settings are required by law, specialized equipment, or scientific experimentation needs.

#### ***4.4.4 Optimize Building Occupancy Scheduling***

Scheduling of building and facility usage should be optimized to be consistent with the approved academic and nonacademic programs and to reduce the number of buildings operating at partial or low occupancy. To the extent possible, academic and nonacademic (community) programs should be consolidated to achieve the highest building utilization. Furthermore, facilities should be scheduled to allow HVAC systems to be shut down to the greatest extent possible during the weekend and other holiday periods. In addition, campus and district staff should make all attempts to change or update building operating schedules to match the changes in the academic programs continually. Making significant changes in this area will require a concerted education process for building users by district facilities staff.

The district will also consider scheduling changes and the possibility of remote learning opportunities post-COVID-19. This opportunity to re-think traditional learning environments and schedules may lead to energy use and GHG emission reduction.

#### ***4.4.5 Optimize HVAC Equipment Scheduling***

All air conditioning equipment, including supply and return air fans, should be shut off on weekends, holidays, and for varying periods each night, except where it would adversely affect instruction, electronic data processing installations, or other scientifically critical or 24-hour operations. The district should avoid cooling and heating spaces when unnecessary. This would be accomplished by scheduling HVAC systems off during unoccupied times while implementing a pre-cooling strategy to cool the building in the early hours of the morning before outside

temperatures heat up. For central plant systems scheduling lockouts for chillers and boilers could be employed to avoid running this equipment when unneeded. It's important to note that some facilities are used late into the evening and on weekends, and accommodations will be made to ensure these operational needs are supported.

#### ***4.4.6 Install Meters and Benchmark at the Building and System Level***

As described above, in March and April 2021, the district performed a benchmarking study of energy usage at the master metered campus level for Foothill College, De Anza College, and the Sunnyvale Center. The results established Energy Use Intensity (EUI) for each site in kBtu/square-foot compared to other similar uses and community college campuses as a starting point for energy planning. The results of the campus wide benchmarking can be found in Appendix F.

Benchmarking energy use at the campus level is an essential first step in identifying high energy use facilities. However, to better isolate excess usage and investigate mitigation measures, the district plans to install electric, natural gas, and BTU meters (to measure central plant hot water energy) at every building and central plant system on the campuses. The district could then connect the individual building meters to both the Gridium EIS and EPA Portfolio Manager, to understand usage trends, benchmark them to similar higher education uses, and target measures to improve energy performance at the building level.

#### ***4.4.7 Pursue Monitoring-Based Commissioning (MBCx)/Retro-commissioning (RCx)***

For buildings or central plant systems determined to be high energy users through the benchmarking process, the district would implement a Monitoring-Based Commissioning (MBCx) or Retro-Commissioning (RCx) process to reduce energy usage at those facilities. MBCx is a process that optimizes building performance for comfort and energy use by using meters and analyzing system performance. RCx is a process that identifies individual energy efficiency projects to improve the control of the system to reduce energy use. For more information about MBCx and RCx, go to: <http://www.ccutilitypartnership.com>

The district has successfully employed the MBCx/RCx process in recent years as part of the Proposition 39 program. In 2016 two MBCx projects were completed successfully at the De Anza cogeneration system and the S-Quad building complex. These projects save 18,000 kWh and 8,000 therms annually with an avoided energy cost of \$9,812 every year.

#### ***4.4.8 Perform Regular Maintenance on Equipment***

Effective preventive and regular maintenance programs keep equipment and systems operating optimally and reduce excess energy use. The district will continue routine maintenance schedules to ensure proper maintenance is performed and revise practices necessary to optimize energy performance.

#### ***4.4.9 Prepare a Climate Adaptation and Resiliency Plan***

As the effects of climate change become more evident each day, it will be vital for the district to develop a Climate Adaptation and Resiliency Plan to prepare the campuses for current and future emergencies. Emergency preparedness programs will be important in the face of increased wildfires and drought. Due to the instability of the electric grid and ongoing PG&E Public Safety Power Shutoffs (PSPS), the district plans to evaluate power

resiliency options. These could include Solar PV/Battery Energy Storage Microgrid systems which can “island” a campus from the electric grid and allow facilities to continue to operate during a power outage. These islanded facilities can provide a community service by providing a refuge or gathering place during prolonged outages or serve as cooling centers in the case of extreme heatwaves.

## 4.5 SUSTAINABLE BUILDING PRACTICES

Construction and renovation of new and existing facilities provide a significant opportunity to reduce the environmental impacts of the built environment through sustainable building practices which also can lead to increased well-being of building users. Where possible, the district will continue to incorporate energy- and resource-efficient “green building” practices in the design and construction of all new and renovated facilities.

### 4.5.1 Establish a Green Building Standard

It is important for the district to adopt appropriate green building standards for new construction and major renovation projects as part of implementing the Measure G Bond program. This will ensure that projects will be energy-efficient and help the district achieve its carbon reduction goals. Minimum standards are mandated by state building codes such as CALGreen. CALGreen is California’s first green building code and first in the nation state-mandated green building code. It is formally known as the California Green Building Standards Code, Title 24, Part 11, of the California Code of Regulations <https://codes.iccsafe.org/content/CAGBSC2019/cover>.



CALGreen aims to improve public health, safety, and general welfare through enhanced design and construction of buildings using concepts that reduce negative impacts and promote those principles that have a positive environmental impact and encourage sustainable construction practices.

While state building codes provide high levels of construction energy efficiency, the path to decarbonization will require advanced strategies beyond those required by state code. These requirements will be evaluated and adopted based on best practices, industry standards, professional organizations, or other institutions of higher education, including the CCC Board of Governors Climate Change and Sustainability Policy.

Well-known standards include the US Green Building Council LEED rating system (<https://www.usgbc.org/leed>), which is the leading program for green buildings and communities worldwide. The district already has constructed several LEED equivalent buildings. In addition, the Association for the Advancement of Sustainability in Higher Education (<https://www.aashe.org/>) provides resources and guidelines for the sustainable construction of higher



education facilities. The UC Berkeley Carbon Initiative provides guidelines to achieve carbon neutrality for the UC system by 2025 (<https://www.ucop.edu/sustainability/policy-areas/green-building/index.html>). Finally, the High-Performance Building Standards (<https://secondnature.org/solutions-center/high-performance-building-standards/>) developed by Second Nature are standards and procedures that promote best sustainability practices in higher education building design and construction.

The district does employ LEED equivalent standards as a practice but will consider adopting these as policy as part of this task. It is important to note that the Foothill College Sunnyvale Center has been awarded LEED Platinum certification and can be a model for future building construction at the district.

#### **4.5.2 Implement Sustainable Design Practices**

New green building standards will require that new construction, renovation, maintenance, and repair projects be designed to consider optimum energy utilization, low life cycle operating costs, and compliance with the district's goals and applicable energy codes and regulations. The district will address energy-efficient and sustainable design early in the project planning and design phases to maximize cost-effectiveness.

The following elements will be considered in the design of all buildings for the district:

- Siting and design considerations that optimize local geographic features to improve the sustainability of the project, such as proximity to public transportation, consideration of microclimates, and passive or active solar energy opportunities
- Durable systems and finishes with long life cycles that minimize maintenance and replacement
- Use of recycled building materials
- Optimization of layout and design of spaces to accommodate reconfiguration, with the expectation that the facility should be renovated and reused (versus demolished)
- Optimization of indoor environmental quality for occupants
- Utilization of environmentally preferable products and processes, such as recycled content materials and recyclable materials
- Systems that monitor, trend, and report operational performance
- Support of an active program for recycling and reuse of materials in each building
- Outdoor spaces designed to use permeable pavement and provide shade through the planting of trees to prevent the heat island effect
- Sustainable landscaping practices
- ENERGY STAR® rated or equivalent equipment in new or renovated buildings whenever possible
- Construction and demolition Recycling Program for all new construction and major renovations

#### **4.5.3 Use an Integrated Systems Approach in Building Design**

Sustainable building strategies should be evaluated to identify economic and environmental performance criteria, evaluate life cycle savings, and adopt an integrated systems approach. Such an approach treats the entire building as one system. It recognizes that individual building features, such as lighting, windows, heating, and cooling systems should be evaluated and designed as interactive systems. In addition, the true economic, social, and environmental impacts of energy and sustainability projects will also be considered (see Section 4.8.2).

#### 4.5.4 Hire Sustainable Building Design Professionals

The district should implement policies to utilize architectural firms, consultants, and energy engineers experienced in all phases of the sustainable building design process to construct energy and resource-efficient buildings. The district should also take advantage of the utility-provided energy efficiency new construction design programs, such as PG&E's Savings by Design ([https://www.pge.com/en\\_US/large-business/save-energy-and-money/facility-improvement/savings-by-design.page?WT.mc\\_id=Vanity\\_savingsbydesign](https://www.pge.com/en_US/large-business/save-energy-and-money/facility-improvement/savings-by-design.page?WT.mc_id=Vanity_savingsbydesign)) and Silicon Valley Clean Energy Building Electrification Technical assistance (<https://www.svcleanenergy.org/building-tech-assist/>).

#### 4.5.5 Commission New Buildings

All new buildings are commissioned after construction or after major renovations to ensure that systems were installed and operating as designed. Individual systems are also commissioned to ensure that they run as efficiently as possible. This will be especially important based on the significant construction and renovations from the Measure G Bond program. At a minimum, the district will comply with the State of California Non-Residential Commissioning Requirements in the 2019 Energy Code ([https://www.energy.ca.gov/sites/default/files/2021-04/2019%20Commissioning\\_ada.pdf](https://www.energy.ca.gov/sites/default/files/2021-04/2019%20Commissioning_ada.pdf)).

## 4.6 ON-SITE GENERATION AND RENEWABLE ENERGY

The district has implemented many on-site solar PV and cogeneration projects on both the Foothill and De Anza campuses. In addition, the district has taken advantage of utility programs for the purchase of renewable and carbon-free offsite grid energy. Despite these renewable energy accomplishments, more will need to be done to achieve the carbon reduction goals of the district, especially electrification of HVAC and EV charging.

#### 4.6.1 Evaluate Load Shifting Technologies

A prerequisite for installing renewable energy systems is to maximize energy efficiency at facilities and reduce peak loads to prevent oversizing generation equipment and the resulting unnecessary costs. Section 4.3 of the Energy Master Plan addresses the energy efficiency component of this equation. Reducing peak electricity loads and utility demand charges can be accomplished by participation in utility Demand Response programs (see Section 4.3.6). In addition, Battery Energy Storage (BES) technologies can use excess solar generation to supply loads in the afternoon and evening peak periods (4 to 9 p.m.). Thermal Energy Storage (TES) can provide chilled and hot water during the same period to offset electric usage. The district will evaluate both these technologies as a part of the district Electrification Feasibility Study described in Section 4.2.2 of the EMP as well as the TOTEM specification for thermal energy microgrids described in Section 4.2.4.



#### 4.6.2 Minimize Greenhouse Gas Intensity of Purchased Electricity

Another way to increase the percentage of renewable or carbon-free energy at district facilities is through utility-purchased offsite grid energy. The Sunnyvale Center already receives 100% renewable electricity through its electric utility Silicon Valley Clean Energy. Both Foothill and De Anza colleges purchase grid electricity through Constellation New Energy, delivered through PG&E transmission and distribution networks, with a renewable power content of 27%.



The district will explore opportunities to improve the renewable content of purchased electricity for Foothill and De Anza through PG&E or third-party programs. In addition, the district will evaluate the feasibility and potential benefits of investing in offsite renewable generation through project ownership or power purchase agreements (PPAs) with a goal of 100% renewable energy at the campuses. The district will not pursue renewable energy through the purchase of renewable energy credits (RECs).

#### 4.6.3 Perform Feasibility Study for additional Solar PV at Campuses

As described above, the district has already installed significant solar photovoltaic (PV) systems at the Foothill and De Anza campuses. To achieve their carbon reduction goals, additional solar capability will likely need to be installed. This evaluation will be part of the proposed Electrification Feasibility Study as described in Section 4.2.2.

#### 4.6.4 Evaluate Campus Resiliency Options

As part of the Climate Adaptation and Resiliency Plan (Section 4.4.9), the district can evaluate several options to improve energy supply resiliency. This will include combining existing and new solar PV generation with battery energy storage (BES) as a means of offsetting peak loads during the late afternoon and early evening when solar generation winds down. The district also intends to evaluate resilience-focused microgrid applications for emergency response and mitigate the impacts of PG&E's Public Safety Power Shutoff (PSPS) events. Microgrids consist of solar PV generation, battery energy storage, and sophisticated controls that permit "islanded" operation of certain campus facilities and systems in the event of a utility power outage. These facilities could serve as emergency community centers or serve as cooling centers during extreme heat events. Power outages are becoming more common due to climate change and wildfire risk, and microgrids with significant electric energy storage can provide resiliency of operations for both the campuses and the larger community.

## 4.7 TRANSPORTATION, COMMUTING, CAMPUS FLEET AND TRAVEL

The ESAC will participate in existing district activities to improve vehicle transportation efficiency and defer evaluation of public transportation programs pending a comprehensive Sustainability Plan developed in 2022. The district will strive to reduce vehicle miles traveled (VMT) for both students and employees commuting to the campus to reduce greenhouse gas emissions and minimize the infrastructure costs related to parking. The district will also evaluate the expansion of existing infrastructure for electric vehicle (EV) charging to meet the state of California and the state Chancellor's Office goals for accommodating EV chargers on the campuses.

### 4.7.1 *Participate in District Transportation Surveys and Analysis*

The district anticipates conducting post-COVID transportation surveys for students and employees to better understand VMT to and from campuses, commuting patterns, and carpooling behaviors as a baseline for improvement. In addition, an analysis of continued remote learning and working is being evaluated as a means of VMT reduction. The ESAC will engage with students to participate in this project as a both a learning opportunity, and foundation for engagement of solutions.

### 4.7.2 *Analyze and Install Electric Vehicle (EV) Charging using On-Site Solar PV Electricity*



The district has installed significant electric vehicle (EV) charging infrastructure in the past, including 10 Level 2 chargers on the De Anza campus and 13 installed at Foothill. As described above, through the energy code and the state Chancellor's Office, the state of California is developing guidance on the percentage and type of chargers required based on total parking spaces. The district will apply this guidance in planning for additional charging stations. In addition, the district will evaluate technologies and install autonomous vehicle fast-charging stations anticipating their future deployment on the roads.

## 4.8 STUDENT AND CURRICULUM DEVELOPMENT

The primary purpose of the California Community Colleges system is to educate students and foster their success by preparing them to be engaged members of society and to be prepared for the careers of tomorrow. As economic, environmental, and social sustainability becomes increasingly important in all facets of society, the California Community Colleges system has a responsibility for moving the current and future generations toward a sustainable future.

Greening educational curriculum – using campus wide infrastructure as a pedagogical tool to inform students about systems thinking and develop a holistic view of education for sustainable development – is a priority in achieving this goal. By embedding social responsibility and sustainable development strategies into existing courses and encouraging new curricula with an environmental and sustainability focus, the community college system can play a crucial role in developing an environmentally sustainable future.

The district will strive to create opportunities for student involvement, so that on-campus sustainability initiatives are transparent, accessible, and have a visible focus. Through this process, faculty, staff, administrators and students would be able to work together to become effective agents for positive change.

#### **4.8.1 Training Opportunities for Students**

Through engaging and recruiting students for participation in energy and sustainability projects, the district can provide a critical training opportunity. For example, students could assist in data gathering, analysis, project scoping, and following projects through design, installation, startup, and commissioning. Students would be able to augment their classroom learning with hands-on experience by applying what they have learned to the real world. Students already participate in selected energy programs and projects, such as the preliminary stages of the TOTEM analysis.

#### **4.8.2 Curriculum Development**

The ESAC will reach out to the faculty and the district Academic Senate to explore learning opportunities for students related to energy and sustainability activities. One option could be to invite a member of each college Academic Senate to participate in ESAC meetings for this discussion and for them to report back to the full senate for consideration. This strategy and possibly others will be evaluated and will require leadership from the faculty for adoption.



#### **4.8.3 Research True Economic, Social, and Environmental Impacts of Energy and Sustainability Activities**

Many energy efficiency and sustainability projects have some negative impacts that are often overlooked when making plans and decisions designed to improve sustainability. While the life cycle environmental benefits of these technologies outweigh the status quo fossil fuel energy system, the tradeoffs should be understood so informed decisions can be made.

The district will work to ensure energy and sustainability activities consider economic constraints, actual environmental and social impacts (including material, manufacturing, and disposal impacts), equipment maintenance considerations, and lifecycle analysis. This should be an evaluated, quality control process, using data and information as a basis for decisions. Students will be engaged as a resource for research and reporting findings to the ESAC and district administration and this will continue on an ongoing basis.

## **4.9 CAMPUS AND COMMUNITY OUTREACH & AWARENESS**

The sustainability of a college campus is highly dependent on individual members of the student body, faculty, and staff. While having energy-efficient equipment, installing low flow water devices, and providing separate bins for source separation of waste can make a district more sustainable, behavioral changes can significantly impact

the effectiveness of these activities. Additionally, it is essential to maintain transparency and keep the campus and local community informed of the district's progress with sustainability planning and actions.

#### 4.9.1 Enhance ESAC Website

The ESAC has established a website to communicate energy and sustainability planning and activities to students, faculty and staff at the district, as well as to the larger community.

While the existing webpage fulfills the primary goals of communicating sustainability activities, the ESAC intends to improve and enhance the site to provide a more detailed, comprehensive and up-to-date picture

of energy and sustainability programs and projects for all campus stakeholders. The website can serve as a publicity tool for sustainability events and student groups and a coordination tool for conveying information to the local community. The website would be managed by the Director of Sustainability (when one is appointed) or a designated member of the ESAC. It should be kept up to date with the latest district and campus developments and link to any public reports about sustainability efforts described in Section 5 of the Energy Master Plan. The website can be found here: <https://www.fhda.edu/about-us/participatorygovernance/D-Energy-and-Sustainability-Advisory-Committee.html>



#### 4.9.2 Inter-Campus Collaboration

It's vitally important that both Foothill and De Anza cooperate and collaborate on energy and sustainability programs and activities to ensure the best possible chance that common district goals are achieved. Unfortunately, many multi-campus community college districts operate in "silos" where each campus works independently on energy and sustainability, resulting in duplication of efforts, inefficient resource utilization, and little

sharing of lessons learned (both good and bad) or the inclusion of best practices. As a districtwide committee, the ESAC will provide the opportunity for collaboration and allow a consistent approach for both campuses to meet their operational needs.

## SECTION 5. MEASURE AND REPORT PERFORMANCE

As with any successful program, the ongoing progress and performance of Energy Master Plan activities should be monitored and compared to goals, objectives, and criteria. This will require continuous participation of the ESAC, college staff, and other participants in the process. The Energy Master Plan activities will be communicated to the larger campus community regularly to ensure transparency and accountability. The following section describes the process for measuring and reporting sustainability activities and achievements.

### 5.1 MEASURING PERFORMANCE

To monitor the district's progress towards its sustainability goals, the ESAC plans to collect information on key



metrics associated with Energy Master Plan Objectives at regular intervals. This will provide a benchmark for progress over time and identify when corrective action is needed to ensure progress. Metrics are performance-based and reflect the outcomes of the energy and sustainability projects, such as GHG emissions reductions or VMTs reduced, rather than the number of projects implemented. However, a description of projects implemented should be included as part of the annual report to show what actions the district has taken to meet the goals. The report would measure any direct cost savings experienced as a result of sustainability projects

### 5.2 REPORTING PERFORMANCE

Measuring and reporting performance and progress is essential in maintaining transparency in energy and sustainability activities and assessing progress towards goals. The target audience of the reports will be the Board of Trustees, shared governance committees, and the district community at large.

Progress reports should include the following information:

- Recap of EMP mission, goals, and objectives
- How is the district performing compared to the goals and objectives?
- What was accomplished?
- Next steps and planned activities
- Key contributor acknowledgements and contact information

The details of the performance metrics and reporting protocols are described in the table on the next page.

**Table 3 – Performance Measurement and Reporting Protocols**

EMP Objective	Description	Performance Metrics	Measurement Frequency	Reporting Protocol	Responsibility
1	District Carbon Reduction Goals	Reduce GHG emissions 50% from 2005 levels by 2030	Annual	Annual Report to SGC/BOT in November; Posted on ESAC website.	Director of Sustainability
1	District Carbon Reduction Goals	Transition to natural gas free by 2035	Annual	Annual Report to SGC/BOT in November; Posted on ESAC website.	Director of Sustainability
1	District Carbon Reduction Goals	Purchased electricity will be 100% renewable by 2045 (SB 100)	Annual	Annual Report to SGC/BOT in November; Posted on ESAC website.	Director of Sustainability
1	District Carbon Reduction Goals	Carbon Neutrality by 2045 (EO B-55-18)	Annual	Annual Report to SGC/BOT in November; Posted on ESAC website.	Director of Sustainability
2	Electric Vehicle Charging (EV) Infrastructure	Deploy EV charging infrastructure consistent with state and CCCCCO goals and timelines for electrification of transportation (2025-2030)	Annual	Annual Report to SGC/BOT in November; Posted on ESAC website.	Director of Sustainability
3	Reduce Vehicle Miles Traveled (VMT)	Reduce Vehicle Miles Traveled (VMT) for students, faculty and staff by 25-50% by 2035 by coordinating with other ongoing district programs	Annual	Annual Report to SGC/BOT in November; Posted on ESAC website.	Director of Sustainability
4	Campus Resiliency	Evaluate campus resiliency opportunities by 2022-2025	Annual 2022-2025	Report to SCG/BOT November 2025; Post on ESAC website.	Director of Sustainability
5	Institutionalize Energy and Sustainability Management	Investigate most effective ways to institutionalize energy and sustainability management in district operations. Completed by 2022-2025.	Annual 2022-2025	Report to SCG/BOT November of 2025; Post on ESAC website.	Director of Sustainability



EMP Objective	Description	Performance Metrics	Measurement Frequency	Reporting Protocol	Responsibility
6	Engage Students, Faculty, and Staff in Sustainability Activities	Develop processes to engage students, faculty, and staff in energy and sustainability activities in a meaningful way in 2021	November 2021	Report to SCG/BOT November of 2021; Post on ESAC website.	Director of Sustainability
7	Student Learning Activities	Encourage and facilitate student learning activities related to energy and carbon reduction by November 2022	November 2022	Report to SCG/BOT November of 2022; Post on ESAC website.	Director of Sustainability
8	Enhance Campus and Community Engagement	Enhance ESAC website to better communicate district energy and sustainability activities in 2022. Defer other program activities pending comprehensive Sustainability Plan in 2022.	Ongoing	Annual Report to SGC/BOT in November	Director of Sustainability
9	Consider Broader Economic and Environmental Impacts	Ensure energy and sustainability activities consider broader economic and environmental impacts	Ongoing	Annual Report to SGC/BOT in November; Posted on ESAC website.	Director of Sustainability

Notes:

- (1) Carbon reduction goals for Scope 1 and Scope 2 GHG emissions.
- (2) Dates are calendar years unless otherwise noted.
- (3) SCG = Shared Governance Committees, BOT= Board of Trustees, ESAC = Energy and Sustainability Advisory Committee

## **SECTION 6. APPENDICES**

**APPENDIX A – District Proposition 39 Projects, 2013-2019**

**APPENDIX B -- Implementation Programs and Plans Checklist**

**APPENDIX C – EMP Gantt Chart Schedule**

**APPENDIX D – Measure G Bond Energy-Saving Projects**

**APPENDIX E – TOTEM Analysis White Paper**

**APPENDIX F -- 2021 Benchmarking Study Results**

**APPENDIX G – Glossary of Terms**

## **PROPOSITION 39 PROJECTS**

Attached is the listing of Proposition 39 projects completed from 2013-2019 at the district. This data was obtained through the California Energy Commission Proposition 39 searchable database.



<b>Local Education Agency (LEA) Name:</b>	Foothill-DeAnza Community College District
<b>Site Name:</b>	Foothill College
<b>Address:</b>	12345 El Monte Rd
<b>City:</b>	Los Altos Hills
<b>Zip Code:</b>	94022

**Application Number:** FOO THI-1314-001

**Estimated Annual Savings**



0 (kWh)  
**Electric**



0 (therms)  
**Natural Gas**



\$0  
**Energy Cost**

**Estimated Prop. 39 Funds Allocated:** \$100,000

**Estimated Project Cost** \$100,000

**Energy Measures Installed:**

- ASHRAE Level 2 Energy Audit



<b>Local Education Agency (LEA) Name:</b>	Foothill-DeAnza Community College District
<b>Site Name:</b>	Foothill College
<b>Address:</b>	12345 El Monte Rd
<b>City:</b>	Los Altos Hills
<b>Zip Code:</b>	94022

**Application Number:** FOOTHI-1314-007

**Estimated Annual Savings**



16,371 (kWh)  
**Electric**



0 (therms)  
**Natural Gas**



\$2,030  
**Energy Cost**

**Estimated Prop. 39 Funds Allocated:** \$91,586

**Estimated Project Cost** \$104,592

**Energy Measures Installed:**

- B2500 Gym Lighting LEDs



<b>Local Education Agency (LEA) Name:</b>	Foothill-DeAnza Community College District
<b>Site Name:</b>	Foothill College
<b>Address:</b>	12345 El Monte Rd
<b>City:</b>	Los Altos Hills
<b>Zip Code:</b>	94022

**Application Number:** FOOTHI-1415-001

**Estimated Annual Savings**



112,614 (kWh)  
**Electric**



1,916 (therms)  
**Natural Gas**



\$15,344  
**Energy Cost**

**Estimated Prop. 39 Funds Allocated:** \$327,945

**Estimated Project Cost** \$356,888

**Energy Measures Installed:**

- Foothill Library Boiler Replacement and Pump Upgrade with VFD
- B2600 Gym Lighting LEDs



<b>Local Education Agency (LEA) Name:</b>	Foothill-DeAnza Community College District
<b>Site Name:</b>	Foothill College
<b>Address:</b>	12345 El Monte Rd
<b>City:</b>	Los Altos Hills
<b>Zip Code:</b>	94022

**Application Number:** FOO THI-1516-001

**Estimated Annual Savings**



25,000 (kWh)  
**Electric**



0 (therms)  
**Natural Gas**



\$7,550  
**Energy Cost**

**Estimated Prop. 39 Funds Allocated:** \$60,636

**Estimated Project Cost** \$66,636

**Energy Measures Installed:**

- Foothill B7400 MBCx



<b>Local Education Agency (LEA) Name:</b>	Foothill-DeAnza Community College District
<b>Site Name:</b>	DeAnza College
<b>Address:</b>	21250 Stevens Creek Blvd
<b>City:</b>	Cupertino
<b>Zip Code:</b>	95014

**Application Number:** FOO THI-1314-001

**Estimated Annual Savings**



0 (kWh)  
**Electric**



0 (therms)  
**Natural Gas**



\$0  
**Energy Cost**

**Estimated Prop. 39 Funds Allocated:** \$100,000

**Estimated Project Cost** \$100,000

**Energy Measures Installed:**

- ASHRAE Level 2 Energy Audit





<b>Local Education Agency (LEA) Name:</b>	Foothill-DeAnza Community College District
<b>Site Name:</b>	DeAnza College
<b>Address:</b>	21250 Stevens Creek Blvd
<b>City:</b>	Cupertino
<b>Zip Code:</b>	95014

**Application Number:** FOOTHI-1314-005

**Estimated Annual Savings**



140,944 (kWh)  
**Electric**



54,064 (therms)  
**Natural Gas**



\$56,403  
**Energy Cost**

**Estimated Prop. 39 Funds Allocated:** \$713,853

**Estimated Project Cost** \$770,000

**Energy Measures Installed:**

- HHW Pump VFD Retrofit, 2 x 15 hp
- Pool Boiler and Distribution Retrofit



<b>Local Education Agency (LEA) Name:</b>	Foothill-DeAnza Community College District
<b>Site Name:</b>	DeAnza College
<b>Address:</b>	21250 Stevens Creek Blvd
<b>City:</b>	Cupertino
<b>Zip Code:</b>	95014

**Application Number:** FOOTHI-1415-001

**Estimated Annual Savings**



63,061 (kWh)  
**Electric**



13,778 (therms)  
**Natural Gas**



\$17,305  
**Energy Cost**

**Estimated Prop. 39 Funds Allocated:** \$32,609

**Estimated Project Cost** \$59,733

**Energy Measures Installed:**

- Library AHUs Premium Efficiency Motors
- De Anza Library AHU-2, 4, 9, 10 VAV Upgrade



<b>Local Education Agency (LEA) Name:</b>	Foothill-DeAnza Community College District
<b>Site Name:</b>	DeAnza College
<b>Address:</b>	21250 Stevens Creek Blvd
<b>City:</b>	Cupertino
<b>Zip Code:</b>	95014

**Application Number:** FOOTHI-1415-005

**Estimated Annual Savings**



42,736 (kWh)  
**Electric**



0 (therms)  
**Natural Gas**



\$5,128  
**Energy Cost**

**Estimated Prop. 39 Funds Allocated:** \$405,001

**Estimated Project Cost** \$735,816

**Energy Measures Installed:**

- Science Building Chiller



<b>Local Education Agency (LEA) Name:</b>	Foothill-DeAnza Community College District
<b>Site Name:</b>	DeAnza College
<b>Address:</b>	21250 Stevens Creek Blvd
<b>City:</b>	Cupertino
<b>Zip Code:</b>	95014

**Application Number:** FOOTHI-1516-001

**Estimated Annual Savings**



18,000 (kWh)  
**Electric**



8,000 (therms)  
**Natural Gas**



\$9,812  
**Energy Cost**

**Estimated Prop. 39 Funds Allocated:** \$280,206

**Estimated Project Cost** \$292,526

**Energy Measures Installed:**

- DeAnza Cogen MBCx
- DeAnza S-Quad MBCx

## **IMPLEMENTATION PROGRAMS AND PLANS CHECKLIST**

A hard copy of the Implementation Programs and Plans Checklist is attached for reference. The electronic copy saved on the ESAC served should be used for managing Energy Master Plan implementation.

## APPENDIX B - PRELIMINARY

### Sustainability Template Plan Summary Implementation Programs and Checklist

**District:** Foothill-De Anza Community College District  
**Campus:** District-wide  
**Project:** Energy Master Plan  
**Date:** 7/1/2021

Click Here to go to **Output Tab**

Plan Section	Template Plan Section Description	# of Programs Available	# of Programs Selected	# of Selected Programs Completed
<a href="#">4.1</a>	Management and Organizational Structure	9	4	2
<a href="#">4.2</a>	Carbon Reduction Programs	4	4	0
<a href="#">4.3</a>	Energy Efficiency	13	9	0
<a href="#">4.4</a>	Facilities Operations	9	9	0
<a href="#">4.5</a>	Sustainable Building Practices	7	4	0
<a href="#">4.6</a>	On Site and Renewable Generation	6	2	0
<a href="#">4.7</a>	Transportation, Commuting, and Campus Fleet and Travel	6	2	0
<a href="#">4.8</a>	Student and Curriculum Development	7	2	0
<b>Totals</b>		<b>61</b>	<b>36</b>	<b>2</b>

## APPENDIX B - PRELIMINARY

### Sustainability Template Programs Chart

**District:** Foothill-De Anza Community College District  
**Campus:** District-wide  
**Project:** Energy Master Plan  
**Date:** 7/1/2021

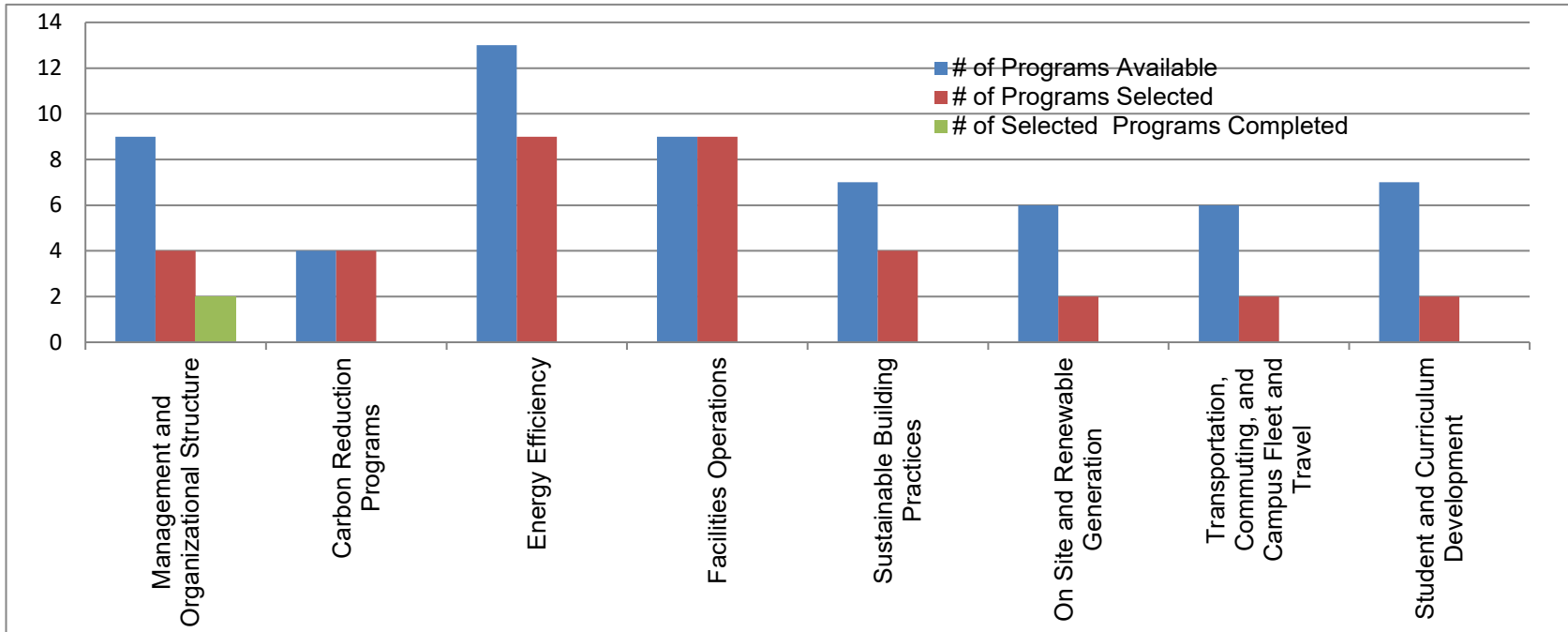

## APPENDIX B - PRELIMINARY

### Sustainability Template Plan Implementation Programs and Plans Checklist

**District:** Foothill-De Anza Community College District  
**Campus:** District-wide  
**Project:** Energy Master Plan  
**Date:** 7/1/2021

**Priority Implementation Plans Indicated Below**

Selected Programs and Plans for Implementation are Summarized Below		
Section 4.1	MANAGEMENT AND ORGANIZATIONAL STRUCTURE	Comments
<input checked="" type="checkbox"/>	4.1.1	Adopt a District Sustainability Policy
<input type="checkbox"/>		Appoint a Sustainability Coordinator, Establish an Office of Sustainability
<input checked="" type="checkbox"/>	4.1.2	Appoint a Campus Sustainability Committee
<input type="checkbox"/>		Funding and Resources to Support Sustainability Activities
<input type="checkbox"/>		Employ Sustainability Professionals, as required
<input type="checkbox"/>		Consider Sustainability in Endowment Investments
<input type="checkbox"/>		Integrate Sustainability Planning into Campus Master Plan
<input checked="" type="checkbox"/>	4.1.3	Investigate most effective ways to institutionalize Energy and Sustainability Management
<input checked="" type="checkbox"/>	4.1.4	Participate in CCC System-wide energy and Sustainability Committees

See Sustainability Template Plan Section 7.1 for Details of Implementation Plans.



Back to Summary Tab



## APPENDIX B - PRELIMINARY

### Sustainability Template Plan Implementation Programs and Plans Checklist

**District:** Foothill-De Anza Community College District  
**Campus:** District-wide  
**Project:** Energy Master Plan  
**Date:** 7/1/2021

#### Priority Implementation Plans Indicated Below

Selected Programs and Plans for Implementation are Summarized Below			
Section 4.2 CARBON REDUCTION PROGRAMS			Comments
<input checked="" type="checkbox"/>	4.2.1	Implement Measure G Bond Projects	See "FHDA Bond Project List FINAL 052021"
<input checked="" type="checkbox"/>	4.2.2	Perform Feasibility Study for District Electrification	
<input checked="" type="checkbox"/>	4.2.3	Estimate FY 2020-2021 FHDA energy usage and GHG emissions (Scope 1 and Scope 2)	
<input checked="" type="checkbox"/>	4.2.4	Work with SFSU and Electricity de France to complete TOTEM analysis of Bldg. 7400 (CEF) at Foothill College	TOTEM - Tool for Optimization of Thermal and Electric Microgrids (heat pumps, heat recovery)

See Sustainability Template Plan Section 7.13 for Details of Implementation Plans.



[Back to Summary tab](#)

## APPENDIX B - PRELIMINARY

### Sustainability Template Plan Implementation Programs and Plans Checklist

**District:** Foothill-De Anza Community College District  
**Campus:** District-wide  
**Project:** Energy Master Plan  
**Date:** 7/1/2021

**Priority Implementation Plans Indicated Below**

Selected Programs and Plans for Implementation are Summarized Below		
Section 4.3 ENERGY EFFICIENCY	Comments	
<input checked="" type="checkbox"/>	4.3.1	Set Energy Efficiency Goals
<input checked="" type="checkbox"/>	4.3.2	Evaluate Mechanisms for the Implementation of Energy Efficiency Projects <span style="float: right;">Include Best Practices indicated in 4.3.11 below</span>
<input checked="" type="checkbox"/>	4.3.3	Conduct Facility Prioritization Survey
<input checked="" type="checkbox"/>	4.3.4	Conduct Comprehensive Facility Energy Audits
<input checked="" type="checkbox"/>	4.3.5	Implement New and Existing Audit Recommendations
<input type="checkbox"/>		Implement Ongoing Energy Monitoring
<input checked="" type="checkbox"/>	4.3.6	Participate in Demand Response Programs
<input checked="" type="checkbox"/>	4.3.7	Identify and Take Advantage of Grant and Incentive Programs (Funding Study) <span style="float: right;">Perform a funding study. Determine Measure G allowable use (Bond Council). Explore PG&amp;E incentives.</span>
<input type="checkbox"/>		Establish an Energy Efficiency Purchasing Policy
<input checked="" type="checkbox"/>	4.3.8	Efficient Lighting and Lighting Controls <span style="float: right;">4.3.8 Install Energy Efficient Equipment in EMP Document</span>
<input type="checkbox"/>		Install Energy Efficient HVAC Systems
<input checked="" type="checkbox"/>	4.3.9	Manage Plug Loads
<input type="checkbox"/>	4.3.11	Evaluate and apply Best Practices Energy Efficiency Measures

See Sustainability Template Plan Section 7.2 for Details of Implementation Plans.



Back to Summary tab

## APPENDIX B - PRELIMINARY

### Sustainability Template Plan Implementation Programs and Plans Checklist

**District:** Foothill-De Anza Community College District  
**Campus:** District-wide  
**Project:** Energy Master Plan  
**Date:** 7/1/2021

**Priority Implementation Plans Indicated Below**

Selected Programs and Plans for Implementation are Summarized Below		
Section 4.4 FACILITIES OPERATION	Comments	
<input checked="" type="checkbox"/> 4.4.1	Encourage and Support Energy Efficiency Training of Staff	
<input checked="" type="checkbox"/> 4.4.2	Install Energy Management Systems	Evaluate suitability of Gridium EIS. Ensure existing meters are working. Facilities team to take this on.
<input checked="" type="checkbox"/> 4.4.3	Adjust Temperature Set Points and Schedule Operating Times	
<input checked="" type="checkbox"/> 4.4.4	Optimize Building Occupancy Scheduling	Coordinate with distance learning opportunities. Smart scheduling. Post-COVID considerations. Education for bldg. users.
<input checked="" type="checkbox"/> 4.4.5	Optimize HVAC Equipment Scheduling	
<input checked="" type="checkbox"/> 4.4.6	Install Meters and Benchmark at the building and system level.	
<input checked="" type="checkbox"/> 4.4.7	Pursue Monitoring-Based(MBCx)/Retro-Commissioning (RCx)	
<input checked="" type="checkbox"/> 4.4.8	Perform Regular Maintenance on Equipment	
<input checked="" type="checkbox"/> 4.4.9	Prepare Climate Adaptation and Resiliency Plan	

See Sustainability Template Plan Section 7.3 for Details of Implementation Plans.



Back to Summary tab

## APPENDIX B - PRELIMINARY

### Sustainability Template Plan Implementation Programs and Plans Checklist

**District:** Foothill-De Anza Community College District  
**Campus:** District-wide  
**Project:** Energy Master Plan  
**Date:** 7/1/2021

**Priority Implementation Plans Indicated Below**

Selected Programs and Plans for Implementation are Summarized Below			
Section 4.5 SUSTAINABLE BUILDING PRACTICES			Comments
<input checked="" type="checkbox"/>	4.5.1	Establish a Green Building Standard	Prior to Measure G implementation. Research appropriate standards. LEED. Cal Green. Title 24.
<input checked="" type="checkbox"/>	4.5.2	Implement Sustainable Design Practices	Prior to Measure G implementation.
<input checked="" type="checkbox"/>	4.5.3	Use an Integrated Systems Approach in Building Design	Prior to Measure G implementation.
<input checked="" type="checkbox"/>	4.5.4	Hire Sustainable Building Design Professionals	Prior to Measure G implementation.
<input checked="" type="checkbox"/>	4.5.5	Commission New Buildings	Measure G program
<input type="checkbox"/>	7.4.3.1	<i>Enter Other Program and Project 1, text will change color</i>	
<input type="checkbox"/>	7.4.3.2	<i>Enter Other Program and Project 2, text will change color</i>	

See Sustainability Template Plan Section 7.4 for Details of Implementation Plans.



Back to Summary tab

## APPENDIX B - PRELIMINARY

### Sustainability Template Plan Implementation Programs and Plans Checklist

**District:** Foothill-De Anza Community College District  
**Campus:** District-wide  
**Project:** Energy Master Plan  
**Date:** 7/1/2021

**Priority Implementation Plans Indicated Below**

Selected Programs and Plans for Implementation are Summarized Below			
Section 4.6 ON-SITE GENERATION AND RENEWABLE ENERGY			Comments
<input type="checkbox"/>	4.5.2.1	Evaluate Clean Cogeneration and Renewable Energy Generation	
<input checked="" type="checkbox"/>	4.6.1	Evaluate Load Shifting Technologies	Battery Energy Storage (BES). Thermal Energy Storage (TES)
<input checked="" type="checkbox"/>	4.6.2	Minimize Greenhouse Gas Intensity of Purchased Electricity	Only 100% renewable generation (not credits). Buy into a project, PPA's?
<input type="checkbox"/>		Evaluate Participation in Community Choice Aggregation	
<input type="checkbox"/>		Identify and Take Advantage of Grant and Incentive Programs	
<input checked="" type="checkbox"/>	4.6.3	Perform Feasibility Study for additional Solar PV at Campuses	
<input checked="" type="checkbox"/>	4.6.4	Evaluate Campus Resiliency Options (Solar/BES/Microgrid)	

See Sustainability Template Plan Section 7.5 for Details of Implementation Plans.



Back to Summary tab

## APPENDIX B - PRELIMINARY

### Sustainability Template Plan Implementation Programs and Plans Checklist

**District:** Foothill-De Anza Community College District  
**Campus:** District-wide  
**Project:** Energy Master Plan  
**Date:** 7/1/2021

**Priority Implementation Plans Indicated Below**

Selected Programs and Plans for Implementation are Summarized Below			
Section 4.7 TRANSPORTATION, COMMUTING, AND CAMPUS FLEET & TRAVEL			Comments
<input checked="" type="checkbox"/>	4.7.1	Participate and coordinate with existing District transportation surveys and analysis of remote learning and working to reduce VMT	Could be a student led project. Defer public transportation programs development pending a comprehensive Sustainability Plan in 2022.
<input type="checkbox"/>		Encourage and Enhance Public Transportation and Ridesharing Options	
<input type="checkbox"/>		Encourage and Enhance Bicycling Options	
<input type="checkbox"/>		Improve Campus Fleet & Travel	
<input type="checkbox"/>		Enhance Student Distance Learning	
<input checked="" type="checkbox"/>	4.7.2	Analyze and Install Electric Vehicle (EV) Charging using on-site Solar PV Electricity. Include analysis of fast-charging autonomous vehicles	Existing Level 2 EV chargers - 10 @ De Anza, 13 @ Foothill Need benchmark for post-carbon world. Will be part of code. CCCCCO guidance.
<input type="checkbox"/>	7.6.3.2	<i>Enter Other Program and Project 2, text will change color</i>	

See Sustainability Template Plan Section 7.6 for Details of Implementation Plans.



Back to Summary tab

## APPENDIX B - PRELIMINARY

### Sustainability Template Plan Implementation Programs and Plans Checklist

**District:** Foothill-De Anza Community College District  
**Campus:** District-wide  
**Project:** Energy Master Plan  
**Date:** 7/1/2021

**Priority Implementation Plans Indicated Below**

Selected Programs and Plans for Implementation are Summarized Below			
Section 4.8 STUDENT AND CURRICULUM DEVELOPMENT			Comments
<input type="checkbox"/>		Create a Sub-Committee in the Academic Senate Devoted to Sustainability	
<input type="checkbox"/>		Provide Professional Development and Create a Faculty Forum	
<input type="checkbox"/>		Utilize Different Pathways to Integrate Sustainability in the Curriculum	
<input type="checkbox"/>		Advocate for Change at the Statewide Level	
<input checked="" type="checkbox"/>	4.8.1	Training Opportunities for Students	Students assist in Energy projects and data analysis
<input checked="" type="checkbox"/>	4.8.2	Engage Faculty and Academic Senate to explore learning opportunities related to energy and sustainability activities	Curriculum Development in EMP Document
<input checked="" type="checkbox"/>	4.8.3	Research true economic, social, and environmental impacts of energy and sustainability projects. Include students in this program.	Ensure activities consider economic constraints, true Environmental Impacts (including material, manufacturing, and disposal impacts), equipment maintenance considerations, and Life-Cycle Analysis. Quality control process. Evaluated process. Use the data to make decisions.

See Sustainability Template Plan Section 7.10 for Details of Implementation Plans.



Back to Summary tab

## APPENDIX B - PRELIMINARY

### Sustainability Template Plan Implementation Programs and Plans Checklist

**District:** Foothill-De Anza Community College District  
**Campus:** District-wide  
**Project:** Energy Master Plan  
**Date:** 7/1/2021

**Priority Implementation Plans Indicated Below**

Selected Programs and Plans for Implementation are Summarized Below		
Section 4.9 CAMPUS AND COMMUNITY OUTREACH & AWARENESS	Comments	
<input checked="" type="checkbox"/> 4.9.1	Enhance ESAC Website to Better Communicate Energy and Sustainability Activities	High Priority now
<input type="checkbox"/>	Hold Workshops and Presentations	
<input type="checkbox"/>	Sustainability Events	
<input type="checkbox"/>	Campus Specific Outreach & Awareness	
<input type="checkbox"/>	Community Specific Outreach & Awareness	
<input type="checkbox"/>	Student and Employee Orientation Program	Education process
<input checked="" type="checkbox"/> 4.9.2	Inter-Campus Collaboration	Driven by ESAC. Integrate sustainability into campus governance structure. Consistent approach for both campuses for operational needs.

See Sustainability Template Plan Section 7.11 for Details of Implementation Plans.



Back to Summary tab



**APPENDIX B - PRELIMINARY**

**Sustainability Template Plan  
Implementation Programs and Plans Checklist**

**District:** Foothill-De Anza Community College District  
**Campus:** District-wide  
**Project:** Energy Master Plan  
**Date:** 7/1/2021



Back to Summary Tab

**Priority Implementation Plans Indicated Below**

Section 4.1 MANAGEMENT AND ORGANIZATIONAL STRUCTURE										
Section	Selected Program or Project	Action Items/Notes	Priority (select)	Status (select)	Linked to	Cost (\$)	Associated OBJECTIVE	Target Completion Date	Assigned To	Email address
4.1.1	Adopt a District Sustainability Policy		High	Complete			5	Complete	ESAC	
4.1.2	Appoint a Campus Sustainability Committee		High	Complete			5	Complete	ESAC	
4.1.3	Investigate most effective ways to institutionalize Energy and Sustainability Management		Med	Planned			5	2022-2025	Dir. Of Sustainability	
4.1.4	Participate in CCC System-wide energy and Sustainability Committees		Med	Planned			5	2022-2025	Dir. Of Sustainability	
Section 4.2 CARBON REDUCTION PROGRAMS										
Section	Selected Program or Project	Action Items/Notes	Priority (select)	Status (select)	Linked to	Cost (\$)	Associated OBJECTIVE	Target Completion Date	Assigned To	Email address
4.2.1	Implement Measure G Bond Projects		High	Planned			1	Bond Schedule	Bond Program/Facilities	
4.2.2	Perform Feasibility Study for District Electrification		High	Planned			1	2022	Facilities	
4.2.3	Estimate FY 2020-2021 FHDA energy usage and GHG emissions (Scope 1 and Scope 2)		High	Planned			1	2022	Dir. Of Sustainability	
4.2.4	Work with SFSU and Electricity de France to complete TOTEM analysis of Bldg. 7400 (CEF) at Foothill College		High	Planned			1	2022	Dir. Of Sustainability	
Section 4.3 ENERGY EFFICIENCY										
Section	Selected Program or Project	Action Items/Notes	Priority (select)	Status (select)	Linked to	Cost (\$)	Associated OBJECTIVE	Target Completion Date	Assigned To	Email address
4.3.1	Set Energy Efficiency Goals		Med	Planned			1	2022-2025	ESAC/ Dir. Of Sustainability - Set to recommend	
4.3.2	Evaluate Mechanisms for the Implementation of Energy Efficiency Projects		High	Planned			1	2022	Bond Program Facilities Dir. Of Sustainability	
4.3.3	Conduct Facility Prioritization Survey		High	Planned			1	2022-2025	Bond Program Facilities Dir. Of Sustainability	
4.3.4	Conduct Comprehensive Facility Energy Audits		Med	Planned			1	2022-2025	Dir. Of Sustainability	
4.3.5	Implement New and Existing Audit Recommendations		Med	Planned			1	2022-2025	Dir. Of Sustainability	
4.3.6	Participate in Demand Response Programs		Med	Planned			1	2023	Dir. Of Sustainability	

Sustainability Template Plan  
Implementation Programs and Plans Checklist

**District:** Foothill-De Anza Community College District  
**Campus:** District-wide  
**Project:** Energy Master Plan  
**Date:** 7/1/2021



[Back to Summary Tab](#)

Priority Implementation Plans Indicated Below

4.3.7	Identify and Take Advantage of Grant and Incentive Programs (Funding Study)		High	Planned			1	2022	Dir. Of Sustainability	
4.3.8	Efficient Lighting and Lighting Controls		High	Planned			1	2022-2025	Bond Program/ Facilities	
4.3.9	Manage Plug Loads		Med	Planned			1	2022-2025	Dir of Sustainability	

Section 4.4 FACILITIES OPERATION

Section	Selected Program or Project	Action Items/Notes	Priority (select)	Status (select)	Linked to	Cost (\$)	Associated OBJECTIVE	Target Completion Date	Assigned To	Email address
4.4.1	Encourage and Support Energy Efficiency Training of Staff		Med	Planned			1	2022	Dir. Of Sustainability	
4.4.2	Install Energy Management Systems		Med	Planned			1	2022-2025	Bond Program / Facilities	
4.4.3	Adjust Temperature Set Points and Schedule Operating		Med	Planned			1	2023	Facilities	
4.4.4	Optimize Building Occupancy Scheduling		Med	Planned			1	2023	District/ Campus/ Facilities	
4.4.5	Optimize HVAC Equipment Scheduling		Med	Planned			1	2023	Facilities/ Dir. Of Sustainability	
4.4.6	Install Meters and Benchmark at the building and system level.		Med	Planned			1	2022-2023	Bond Program/ Dir. Of Sustainability	
4.4.7	Pursue Monitoring-Based(MBCx)/Retro-Commissioning (RCx)		Med	Planned			1	2022	Bond Program/ Facilities/ Dir. Of	
4.4.8	Perform Regular Maintenance on Equipment		High	In-Process			1	Ongoing	Facilities	
4.4.9	Prepare Climate Adaptation and Resiliency Plan		Med	Planned			4	2022-2025	ESAC/ Dir. Of Sustainability	

Section 4.5 SUSTAINABLE BUILDING PRACTICES

Section	Selected Program or Project	Action Items/Notes	Priority (select)	Status (select)	Linked to	Cost (\$)	Associated OBJECTIVE	Target Completion Date	Assigned To	Email address
4.5.1	Establish a Green Building Standard		High	Planned			1	2022	ESAC/ Bond Program/ Facilities/ Dir. Of Sustainability	
4.5.2	Implement Sustainable Design Practices		High	Planned			1	2022	Dir. Of Sustainability/ Bond Program	
4.5.3	Use an Integrated Systems Approach in Building Design		High	Planned			1	2022	Bond Program/ Dir. Of Sustainability/ Facilities	

Sustainability Template Plan  
Implementation Programs and Plans Checklist

**District:** Foothill-De Anza Community College District  
**Campus:** District-wide  
**Project:** Energy Master Plan  
**Date:** 7/1/2021



Back to Summary Tab

Priority Implementation Plans Indicated Below

4.5.4	Hire Sustainable Building Design Professionals		High	Planned			1	Ongoing	Bond Program/ Dir of Sustainability/ Purchasing	
4.5.5	Commission New Buildings		Med	Planned			1	2023	Bond Program/ Dir. Of Sustainability	

Section 4.6 ON-SITE GENERATION AND RENEWABLE ENERGY

Section	Selected Program or Project	Action Items/Notes	Priority (select)	Status (select)	Linked to	Cost (\$)	Associated OBJECTIVE	Target Completion Date	Assigned To	Email address
4.6.1	Evaluate Load Shifting Technologies		Med	Planned			4	2022-2025	Dir. Of Sustainability	
4.6.2	Minimize Greenhouse Gas Intensity of Purchased Electricity		High	Planned			1	2022	Dir. Of Sustainability/ VC Business Services	
4.6.3	Perform Feasibility Study for additional Solar PV at Campuses		High	Planned			1	2022	Dir. Of Sustainability	
4.6.4	Evaluate Campus Resiliency Options (Solar/BES/Microgrid)		Med	Planned			4	2022-2025	Dir. Of Sustainability	

Section 4.7 TRANSPORTATION, COMMUTING, AND CAMPUS FLEET & TRAVEL

Section	Selected Program or Project	Action Items/Notes	Priority (select)	Status (select)	Linked to	Cost (\$)	Associated OBJECTIVE	Target Completion Date	Assigned To	Email address
4.7.1	Participate and coordinate with existing District transportation surveys and analysis of remote learning and working to reduce VMT		High	Planned			3	2022-2023	Dir. Of Sustainability/ Colleges	
4.7.2	Analyze and Install Electric Vehicle (EV) Charging using on-site Solar PV Electricity. Include analysis of fast-charging autonomous vehicles		Med	Planned			2	2025-2030	Bond Program/ Dir. Of Sustainability	

Section 4.8 STUDENT AND CURRICULUM DEVELOPMENT

Section	Selected Program or Project	Action Items/Notes	Priority (select)	Status (select)	Linked to	Cost (\$)	Associated OBJECTIVE	Target Completion Date	Assigned To	Email address
4.8.1	Training Opportunities for Students		High	In-Process			7	2023-2025	Deans/ Curriculum Committee/ Dir. Of Sustainability	

**APPENDIX B - PRELIMINARY**

**Sustainability Template Plan  
Implementation Programs and Plans Checklist**

**District:** Foothill-De Anza Community College District  
**Campus:** District-wide  
**Project:** Energy Master Plan  
**Date:** 7/1/2021



[Back to Summary Tab](#)

**Priority Implementation Plans Indicated Below**

4.8.2	Engage Faculty and Academic Senate to explore learning opportunities related to energy and sustainability activities		High	Planned			7	2022-2025	Campus/Senior Management/	
4.8.3	Research true economic, social, and environmental impacts of energy and sustainability projects. Include students in this program.		High	Planned			9	2021-2022	Dir. Of Sustainability/ Faculty/ ESAC	

Section 4.9 CAMPUS AND COMMUNITY OUTREACH & AWARENESS										
Section	Selected Program or Project	Action Items/Notes	Priority (select)	Status (select)	Linked to	Cost (\$)	Associated OBJECTIVE	Target Completion Date	Assigned To	Email address
4.9.1	Enhance ESAC Website to Better Communicate Energy and Sustainability Activities						8	Ongoing	Dir. Of Sustainability	
4.9.2	Inter-Campus Collaboration						6	2022	Colleges/ Dir. Of Sustainability	

## **MS PROJECT GANTT CHART SCHEDULE**

Attached is a MS Project Gantt Chart Schedule outlining the implementation plan for the Energy Master Plan.

**APPENDIX C - PRELIMINARY**

FHDA EMP Schedule  
FINAL DRAFT 8/27/21

ID	Project No.	Task Name	Responsibility	2021	2022	2023	2024	2025	2026	2027	2028	2029	2030	2031	2032
1		<b>PROJECT START</b>			0%										
2	<b>4.1</b>	<b>Management and Organizational Structure</b>													
3	4.1.1	Adopt a District Sustainability Policy	ESAC		100%										
4	4.1.2	Appoint a Campus Sustainability Committee	ESAC		100%										
5	4.1.3	Investigate most effective ways to institutionalize Energy and Sustainability Management	Director of Sustainability												
6	4.1.4	Participate in CCC System-wide Energy and Sustainability Committees	Director of Sustainability												
7	<b>4.2</b>	<b>Carbon Reduction Programs</b>													
8	4.2.1	Implement Measure G Bond Projects	Bond Program, Facilities												
9	4.2.2	Perform Feasibility Study for District Electrification	Facilities												
10	4.2.3	Estimate FY 2020-2021 FHDA energy usage and GHG emissions (Scope 1 and Scope 2)	Director of Sustainability												
11	4.2.4	Work with SFSU and Electricity de France to complete TOTEM analysis of Bldg. 7400 (CEF) at Foothill College	Director of Sustainability												
12	<b>4.3</b>	<b>Energy Efficiency</b>													
13	4.3.1	Set Energy Efficiency Goals	Director of Sustainability												
14	4.3.2	Evaluate Mechanisms for the Implementation of Energy Efficiency Projects	Bond Program, Director of Sustainability												
15	4.3.3	Conduct Facility Prioritization Survey	Bond Program, Director of Sustainability												
16	4.3.4	Conduct Comprehensive Facility Energy Audits	Bond Program, Director of Sustainability												
17	4.3.5	Implement New and Existing Audit Recommendations	Director of Sustainability												
18	4.3.6	Participate in Demand Response Programs	Director of Sustainability												
19	4.3.7	Identify and Take Advantage of Grant and Incentive Programs (Funding Study)	Director of Sustainability												
20	4.3.8	Efficient Lighting and Lighting Controls	Bond Program, Facilities												

**APPENDIX C - PRELIMINARY**

FHDA EMP Schedule  
FINAL DRAFT 8/27/21

ID	Project No.	Task Name	Responsibility	2021	2022	2023	2024	2025	2026	2027	2028	2029	2030	2031	2032
21	4.3.9	Install Energy Efficient HVAC Systems	Bond Program, Facilities												
22	4.3.10	Manage Plug Loads	Director of Sustainability												
23	4.3.11	Evaluate and Apply Best Practices Energy Efficiency Measures	Director of Sustainability												
24	<b>4.4</b>	<b>Facilities Operation</b>													
25	4.4.1	Encourage and Support Energy Efficiency Training of Staff	Director of Sustainability												
26	4.4.2	Evaluate and Install Energy Management Systems	Bond Program, Facilities												
27	4.4.3	Adjust Temperature Set Points and Schedule Operating Times	Facilities												
28	4.4.4	Optimize Building Occupancy Scheduling	Director of Sustainability												
29	4.4.5	Optimize HVAC Equipment Scheduling	Director of Sustainability												
30	4.4.6	Install Meters and Benchmark at the building and system level.	Bond Program, Director of Sustainability												
31	4.4.7	Pursue Monitoring-Based(MBCx)/Retro-Commissioning (RCx)	Bond Program, Director of Sustainability												
32	4.4.8	Perform Regular Maintenance on Equipment	Facilities												
33	4.4.9	Prepare Climate Adaptation and Resiliency Plan	Director of Sustainability												
34	<b>4.5</b>	<b>Sustainable Building Practices</b>													
35	4.5.1	Establish a Green Building Standard	Bond Program, Director of Sustainability, ESAC												
36	4.5.2	Implement Sustainable Design Practices	Bond Program, Director of Sustainability												
37	4.5.3	Use an Integrated Systems Approach in Building Design	Bond Program, Director of Sustainability												
38	4.5.4	Hire Sustainable Building Design Professionals	Bond Program, Director of Sustainability												
39	4.5.5	Commission New Buildings	Bond Program, Director of Sustainability												
40	<b>4.6</b>	<b>On-Site and Renewable Generation</b>													

**APPENDIX C - PRELIMINARY**

FHDA EMP Schedule  
FINAL DRAFT 8/27/21

ID	Project No.	Task Name	Responsibility	2021	2022	2023	2024	2025	2026	2027	2028	2029	2030	2031	2032
41	4.6.1	Evaluate Load Shifting Technologies	Director of Sustainability												
42	4.6.2	Minimize Greenhouse Gas Intensity of Purchased Electricity	Director of Sustainability, VC Business Services												
43	4.6.3	Perform Feasibility Study for additional Solar PV at Campuses	Director of Sustainability												
44	4.6.4	Evaluate Campus Resiliency Options (Solar/BES/Microgrid)	Director of Sustainability												
45	<b>4.7</b>	<b>Transportation, Commuting, and Campus Fleet &amp; Travel</b>													
46	4.7.1	Participate and coordinate with existing District transportation surveys and analysis of remote learning and working to reduce VMT	Director of Sustainability/Colleges												
47	4.7.2	Analyze and Install Electric Vehicle (EV) Charging using on-site Solar PV Electricity. Include analysis of fast-charging autonomous vehicles	Director of Sustainability/Bond Program												
48	<b>4.8</b>	<b>Student and Curriculum Development</b>													
49	4.8.1	Training Opportunities for Students	Deans/ Curriculum Committee/ Dir. Of Sustainability												
50	4.8.2	Engage Faculty and Academic Senate to explore learning opportunities related to energy and sustainability activities	Campus/Senior Management/Faculty												
51	4.8.3	Research true economic, social, and environmental impacts of energy and sustainability projects. Include students in this program.	Dir. Of Sustainability/ Faculty/ ESAC												
52	<b>4.9</b>	<b>Campus and Community Outreach and Awareness</b>													
53	4.9.1	Enhance ESAC Website to Better Communicate Energy and Sustainability Activities	Director of Sustainability												
54	4.9.2	Inter-Campus Collaboration	Director of Sustainability/Colleges												



## **MEASURE G BOND ENERGY-SAVING PROJECTS**

Attached is the listing of the Measure G Bond Energy-Saving projects. These projects will be evaluated as part of the Energy Master Plan implementation.

## APPENDIX D

**FHDA Measure G Bond Energy-Saving Projects  
Foothill College**

ID	Project Description	Energy Component	Notes
FH-002	Heating, Ventilation and Air Conditioning Equipment and System Components and Physical Plants Upgrades	Y	All new heating and cooling systems, distribution, etc
FH-003	Building Exterior, Roofing and Waterproofing Campus-wide Renovations	Y	Exterior shell repairs or replacement includes insulation, better windows, door and door seals, etc for energy saving, etc
FH-004	Infrastructure and Distribution Piping Improvements Heating, Ventilation and Air Conditioning Upgrades Campus-wide	Y	All new heating and cooling system infrastructure/s, distribution, etc
FH-005	Restroom Facilities Upgrades and Improvements	Y	Restroom repairs or replacement includes insulation, more efficient equipment or systems including hot water systems for energy saving, etc
FH-006	Renovate and Expand Student Success Centers	Y	Added space and repairs or replacement includes insulation, more efficient equipment or systems for energy saving, etc
FH-007	Renovate and Upgrade Existing Classroom Facilities	Y	Added classroom space and repairs or replacement includes insulation, more efficient equipment or systems for energy saving, etc
FH-008	Pool and Physical Educational Facilities Improvements	Y	Added PE area space and repairs or replacement includes insulation, more efficient equipment or systems for energy saving, etc
FH-013	Lighting Improvements Campus-wide	Y	Interior campus lighting replacement with LEDs will save energy
FH-014	Natural Gas Service and Distribution Electrification	Y	Limiting gas service and optimizing electrical systems for energy saving
FH-015	Electrical Systems Renovations and Upgrades Campus-wide	Y	Replacing electrical systems will save energy
FH-016	Building Management System Upgrades System-wide	Y	Replacing BMS will help save energy

## APPENDIX D

**FHDA Measure G Bond Energy-Saving Projects  
De Anza College**

ID	Project Description	Energy Component	Notes
DA-003	Perimeter Campus Roadway, Pathway, and Traffic Improvements	Y	Likely energy saving components, needs to be included for traffic impacts in CEQA documentation
DA-005	Replacement of the Creative Arts Quad Buildings	Y	All new heating and cooling system infrastructure/s, distribution, etc
DA-007	Building Exterior, Roofing and Waterproofing Campus-wide Renovations	Y	Exterior shell repairs or replacement includes insulation, better windows, door and door seals, etc for energy saving, etc
DA-008	Infrastructure and Distribution Piping Improvements Heating, Ventilation and Air Conditioning Upgrades Campus-wide	Y	All new heating and cooling system infrastructure/s, distribution, etc
DA-009	Heating, Ventilation and Air Conditioning Equipment and System Components & Physical Plant Operation Upgrades	Y	All new heating and cooling system infrastructure/s, distribution, etc
DA-010	Physical Plant replacement attached to Flint Center and Creative Arts Quad Buildings	Y	All new heating and cooling system infrastructure/s, distribution, etc
DA-012	Student Health Services Renovation	Y	Added space and repairs or replacement includes insulation, more efficient equipment or systems for energy saving, etc
DA-013	Building Interior and Exterior Improvements Campus-wide	Y	Any space with repairs or replacement includes insulation, more efficient equipment or systems for energy saving, etc
DA-014	Physical Education and Gymnasium Building Renovation	Y	Added space and repairs or replacement includes insulation, more efficient equipment or systems for energy saving, etc
DA-016	Pool and Physical Educational Quad Facilities Improvements	Y	Added space and repairs or replacement includes insulation, more efficient equipment or systems for energy saving, etc
DA-017	Automotive Technology Facilities Improvements and Modernization	Y	Added space and repairs or replacement includes insulation, more efficient equipment or systems for energy saving, etc

## APPENDIX D

### FHDA Measure G Bond Energy-Saving Projects Central Services Project List

ID	Project Description	Energy Component	Notes
CS-001	Equipment and Vehicles Acquisitions	Y	State-mandated EVs required as fleet vehicles
CS-003	ETS Storage Facilities	Y	All new heating and cooling system, connect to existing or new infrastructure/s, distribution, etc

## APPENDIX D

### FHDA Measure G Bond Energy Saving Projects Educational Technology Services (ETS) Project List

ID	Project Description	Energy Component	Notes
ETS-001	Learning Space Technology Upgrades and Enhancements	Y	Likely replacement of aged equipment with new, possible energy savings
ETS-002	Academic and Business Computer Refresh	Y	Likely replacement of aged equipment with new, possible energy savings
ETS-003	Servers and Disk Storage Equipment for Remote Desktop Support	Y	Likely replacement of aged equipment with new, possible energy savings
ETS-006	Building-based Network Service Room Upgrades	Y	Likely replacement of aged equipment with new, possible energy savings

## APPENDIX D

### FHDA Measure G Bond Energy Saving Projects District and District-wide Project List

ID	Project Description	Energy Component	Notes
DW-001	De Anza Event Center	Y	All new facility
DW-002	Relocation of Utilities for De Anza Event Center Facility	Y	All new heating and cooling systems, distribution, etc
DW-003	Griffin House Renovations	Y	All new heating and cooling systems in building, connections to existing or new utilities
DW-004	Carriage House	Y	Updated heating and cooling systems in building, connections to existing or new utilities
DW-005	District-wide Energy and Sustainability Projects	Y	New or updated infrastructure requires energy efficiency component/s

## TOTEM WHITE PAPER

Attached is a White Paper describing the TOTEM (Tool for Optimization of Thermal and Electric Microgrids) analysis which will model Foothill College combined electric (power and energy) and thermal (HVAC) system to understand and evaluate thermal microgrid replacement of the natural gas uses.

## APPENDIX E

### A Path to Decarbonization for the California Community College System - White Paper Outline

Sonika Choudhary (EDF), Robert Cormia (Foothill-De Anza district), and Alice Sung (Greenbank)

The California Community College System represents over 2 million students, 115 Colleges, and over 50 million (assignable) square-feet of buildings, with an average age of over 30 years. As a leader in demonstrating energy efficiency, and LEED building, California Community Colleges represent a “leading edge” for incorporating building technology that lowers energy use and cost, with significant impact on Greenhouse Gas Emissions. California’s SB32 2030 Decarbonization Goal brings a special opportunity to the California Community College system. California Community Colleges have already led with significant adoption of solar photovoltaic (PV) energy, cogeneration of heat and power, and support for Electric Vehicle (EV) charging on our campuses, combined with low carbon electricity procurement, have led to significant reductions in Greenhouse gas inventories. Given the age of our buildings, and especially energy infrastructure, the next step in modernization is to replace older, deprecated natural gas fired boilers with electric heat recovery systems. Foothill De Anza College District (Foothill-De Anza district) has committed to an 80% reduction in Greenhouse Gas Emissions by 2030, through a process that combines zero carbon emission electricity with elimination of natural gas from the central HVAC system, replaced by an electric heat recovery “thermal microgrid”. This whitepaper will describe the modeling and analysis requirements to plan such a system, including analysis of current energy use, modeling of power and energy requirements for heat recovery, microgrid architecture (storage and onsite solar PV), engineering and project management, and most importantly, how to fund and maintain the project. Foothill-De Anza district is partnering with Electricity de France (EDF) Innovation labs in Los Altos CA, on a project to begin modeling Foothill’s combined electric (power and energy) and thermal (HVAC) system, to understand and model a thermal microgrid. As an early adopter of a thermal microgrid, these transformative projects can be a model for the California Community College System, and our collective leadership in deep decarbonization. These capital and technology intensive projects also present an economic opportunity for vendors of equipment, system integrators, and utilities, to supply products, services, and end-to-end management for technically demanding infrastructure projects. An analysis of Stanford’s SESI (Stanford Energy System Innovation) program provides insights into the technical and financial paths to achieve transformation of fossil based systems to low carbon heat recovery and distribution, and guidance for the California Community College system. These projects are technically and financially viable paths to our decarbonization goals.

- California Community College system, 115 colleges, 2 million students
- 50 million sq-ft, over half of the system is at least 50 years old
- California deep decarbonization goals, 40% reduction by 2030, 80% by 2045
- Electrification of buildings and carbon free electricity is the path to decarbonization
- Thermal microgrids are the foundation of a low carbon - managed energy system
- Foothill-De Anza district and EDF labs have developed a draft design for a total energy system



## APPENDIX E

- California Community Colleges have a leadership role in large-scale decarbonization
  - Technical and financially viable paths to California's SB32 2030 decarbonization goals
1. California's 2030 Decarbonization Goal

As a follow-on to California's landmark Global Warming Solutions bill AB-32, SB-32 was enacted in 2016 to reach deep decarbonization goals a full 20 years ahead of national goals (80% reduction in GHGs below 1990 levels). The strategy to achieve this goal combines increasing Renewable Portfolio Standards (RPS) for in State and imported electricity, and replacing natural gas fired HVAC infrastructure with thermal / electric heat recovery systems. Electrification of new and existing buildings is central to this goal, including Renewable Energy (RE) as a source of energy for electrified systems. Buildings represent ~ 40% of carbon emissions, and natural gas, either to produce electricity, or for space heating, is the primary source of carbon emissions in buildings (reference to DoE energy statistics).

- AB-32 and SB-32 set clear objectives for GHG reduction
- RPS (Renewable Portfolio Standard) more solar PV, lower carbon intensity electricity
- Building electrification with clean primary energy is the path to eliminating natural gas
- New building codes are eliminating natural gas for HVAC and hot water

2. Age and infrastructure of California Community Colleges

California's Community College System construction began in the late 1950s and early 1960s, with fully half of the buildings approaching 50 years old, with many still using original hydronic (piping) infrastructure. Many Colleges are operating with 20-year-old natural gas fired boilers, that will "age out" in the next 5-10 years. The period from 2020-2030 represents an opportunity to both rebuild our critical Community College energy infrastructure, as well as transform our energy systems to high efficiency low carbon emission infrastructure. The majority of the 2018-19 Capital Outlay Plan for California Community Colleges (ref) is directed to modernization of existing facilities. The convergence of aging infrastructure and decarbonization offers an opportunity to achieve GHG reduction goals through the elimination of natural gas.

- College campuses often have central plants with natural gas boilers / hydronic systems
- Many systems are 50 years old, with need for hydronic upgrades and boiler replacement
- Now is a perfect time for deploying modern electric HVAC, achieving reduction of GHGs

3. Electrification as a path forward - elimination of natural gas

The key mechanism to low carbon emissions is elimination of natural gas from HVAC infrastructure, and that is accomplished by replacing natural gas fired boilers with electric heat recovery systems. As described in the technical component of this whitepaper, electric heat recovery systems "move heat" from one reservoir to another, rather than use combustion or electric resistive systems to provide heat, and traditional mechanical compression to cool. Heat pumps and heat recovery systems are standardized in new building construction in Europe, and are increasingly used in high performance buildings in California, including California's Title 24

## APPENDIX E

building codes requiring Net Zero Energy for new commercial buildings beginning in 2020, and modernization of existing buildings in 2025.

- Natural gas is the largest component of most California college GHG inventories
- Natural gas boilers can be replaced by high efficiency electric heat recovery systems
- In many cases, the existing central plant model can be retained with hydronic upgrades

#### 4. Model systems - Stanford Energy System Innovation (SESI)

SESI (Stanford Energy Systems Innovation), a project begun in 2009-2011, is the first large-scale heat recovery system of its kind implemented on a large college or university campus.

<http://sustainable.stanford.edu/campus-action/stanford-energy-system-innovations-sesi>

The SESI system replaces a complex natural gas thermal system comprising a 25 year-old cogeneration system, and traditional thermal boiler and mechanical HVAC systems. SESI is a large centralized heat recovery system, with a large (125,614 sq-ft) mechanical room, three large storage tanks (~ 12 million gallons) and a direct substation connection to the power grid. The SESI system provides energy to the entire (~ 11 million sq-ft) Stanford campus, has reduced carbon emissions by two-thirds (2017) and more than 80% by 2025 (SESI presentation). The key advances in this system are:

1. Electrification (more efficient energy use)
2. Thermal storage
3. Advanced energy management and analytics
4. Low carbon energy procured through a PPA

The SESI project is a model for California Community Colleges, beginning with the modeling of existing energy use, creating an energy balance model, analysis of coincident heating and cooling, and application of a heat recovery system. The modeling, design, and specification of a project like SESI requires both expertise as well as extensive resources, as described below. SESI worked with Johnson Controls and a number of other vendors to help organize, analyze and model the current energy load, and prepare engineering requirements for the new system.

#### 5. Modeling, design, and specification of projects

The modeling, design, and specification of a new energy system is the focus of this whitepaper, and specifically what resources and expertise are required to assemble data, identify gaps, analyze power, energy, therms, and btu, and develop a comprehensive energy balance model. Once complete, energy management professionals can analyze the model, and work with professional engineers to build an engineering model for the draft design of a heat recovery system. The draft design serves as an RFI/RFQ to enlist quotes and additional perspective on a systems analysis and design. Building modeling (BIMS) is a second level of energy analysis needed in a project of this magnitude, and is essential for “coupling” the building systems with a centralized heat recovery hydronic system. Through the initial modeling of this pilot study,

## APPENDIX E

Foothill College also became aware of instances where heating and cooling were going on simultaneously, due to improper settings in the underlying HVAC infrastructure and controls. These discoveries point to opportunities to reduce energy, and carbon emissions, by an estimated 10% or more, BEFORE replacing the existing system. The technical details of the modeling are described in appendix 1, including datasets showing the BTU flow in and out of a central (HVAC) plant, and the therms and electricity associated with heating and cooling the campus.

- Organization and analysis of thermal plant data is the first step in project exploration
- Electricity (kWh) and natural gas (therms) extracted from utility bills and meters
- BTU transfer (heating and cooling) is a much larger effort, need BTU submetering
- BTU data are used in developing a heat recovery as well as energy balance model

### 6. Power, energy and emission implications

There are significant power and energy requirements to operating a campus wide heat recovery system, which need to be modeled to understand if existing electricity services will be sufficient, the change in peak demand (kW), the total amount of electricity consumed (kWh), and natural gas displaced. This is one of the more difficult but critical components of modeling, and includes the need to properly size electricity contracts (energy. kWh) including power delivery (kW). The SESI system, which provides (1 mmbtu usable heat and 0.85 mmbtu usable cooling, consumes an estimated 321 million kWh annually, which is less than the 388 million kWh produced by the previous cogen system. Natural gas use, of course, has decreased significantly, and will be essentially “phased out” by 2025. The goal of the Foothill-De Anza district project is to replace the entire central plant heating and cooling (traditional chiller / boiler HVAC) with a SESI like heat recovery system. It is anticipated that natural gas will be reduced by 50% (initially) leaving cogeneration and some gas fired boilers in service, to be replaced by heat recovery systems at a later date. Foothill has begun modeling a prototype electrical system comprising an additional 500 kW solar PV array, adding 25% to the system generation capacity, and energy storage, to capture and redirect solar PV sourced energy for heat recovery and other building loads.

- Power (kW) and energy (kWh) requirements of thermal microgrids are significant
- Electricity will replace natural gas for a large fraction of heating
- Ideally, electricity will be sourced from solar PV, wind, and/or large hydro electric
- Natural gas used for HVAC represents a substantial GHG emission reduction target
- A combination of additional onsite solar PV / electrical energy storage are a good fit

### 7. Cost of projects, funding requirements

The cost of a heat recovery system is substantial, the most difficult component of a large capital project, followed closely by the resources to manage a construction project of this size. Even more challenging, very few of these projects have been undertaken at the size of a community college, so even having an approximate idea cost, enough for a capital bond, is challenging. But

## APPENDIX E

without a budget, a capital bond can't be created to fund the design and engineering, infrastructure (capital equipment), construction and project management, and commissioning. Foothill-De Anza district has begun this project through conversations with Stanford University, and vendors Johnson and Johnson, who helped implement the project. Foothill-De Anza district is budgeting ~ \$100M for a complete system, and will look to combine funding from a capital bond, with ESCO (Energy Service Companies). The College may also look to other large project grants, including ARPA-E, that could help "jump-start" the process.

- Capital cost of a heat recovery system is substantial (~ \$12M for Foothill College)
- Heat pump, thermal storage, hydronic upgrades, etc.
- Additional onsite solar PV and electrical energy storage are strongly recommended
- Project installation, operational assistance, and maintenance are ~ 40% of total cost
- Sources of funding include capital bonds, large government / energy grants

### 8. Project management of a system in transition

Project management will be critical to implementing an effective, reliable, high performance and low carbon innovation in energy infrastructure. Stanford (SESI) required a professional engineering firm as well as their internal engineering team to develop, source, implement, and commission their system, roughly a 5 year long project, that still continues in refinement. A project of this magnitude at a typical California Community College would likely last 2-3 years, and be done in phases, to minimize disruption to campus facilities. Managing disruption of services to a campus serving 10,000 students is a challenge, as most people want the benefits of high performance HVAC system, but not the inconvenience of having everything torn up.

- For many if not most colleges, there will be a transitional time during construction
- HVAC services may be curtailed, or offline for periods of time (several weeks / months)
- Managing expectations of employees and students requires effort and coordination

### 9. California Community Colleges as leader in decarbonization

California is arguably the leader in combined policy, technical and commercial development, and innovation, not the least of which is our colleges and universities. Academic and commercial research and development, combined with implementation of LEED, ZNE, and integrated low carbon power and energy infrastructure, creates fertile ground for leading edge energy projects like SESI. More importantly, through policy, funding, and developing shared technical expertise, California can provide the combined financial, technical, and project management support to achieve deep decarbonization. California's decarbonization goals, and support for projects like the (SESI) described in this paper, establish a replicable model for the US, and for the world, and additionally establish California as a technology leader and vendor of products and services to support both new high performance buildings, as well as retrofitting the built environment.

## APPENDIX E

California Community Colleges have a special role in higher education and in the public landscape, as we are visible to so many Californians, students, stakeholders, and the community at large. What we do matters, and especially if we involve the community investing in our infrastructure, reducing greenhouse gas emissions, and creating a better environment.

- California is a leader in innovative and advanced energy technology deployment
- LEED construction, ZNE (Zero Net Energy) buildings, energy efficiency reach codes
- Building electrification with low carbon electricity, energy storage and management
- A suite of infrastructure approaches will help California achieve decarbonization goals

### 10. Value to the community (vendor development)

As mentioned above, vendor development is essential to building an ecosystem of engineers, developers, ESCOs, systems integrators, and financial support for large complex projects like this, which probably range from 50 million to 200 million dollars in scope. The value to the community of having world class (brand name) developers in California not only adds economic value, it adds to our political stature. Beginning with the 2006 landmark legislation Global Warming Solutions Act, California set policy directives that have helped foster commercial development, in carbon markets, building standards, automotive performance, Renewable Energy (RE) development, and in the process, created thousands of jobs, and billions of dollars in value, through a combination of energy savings, environmental protection, and commerce.

- Advanced energy infrastructure investments benefit multiple stakeholders
- Clean energy industry (ESCO), building occupants, and surrounding communities
- These projects pave the way for leadership in decarbonization across all sectors
- California will grow as a leader in advanced energy technology / decarbonization projects
- Thousands of jobs, billions of dollars, energy savings and significant GHG reduction

### 11. Role of California (State) in support of electrification

Electricity is probably the most important “modern invention” that our technology driven society relies upon every day, and will be the foundation to undo dependence on fossil fuels for the energy that drives everything we do today. With non-emission sources of primary energy available to provide clean, affordable, and reliable electricity, and for the built environment, transition from the legacy of natural gas, which touted “clean burning” but still produces significant carbon dioxide emissions. As California leads on climate, we can also lead on electrification, and support for non-emission sources of that electricity. With very little time to transition to a fossil fuel free world, electrification of buildings, transportation, commerce and industry, are a necessary requirement to begin to unwind a path towards catastrophic climate change. In addition to GHG emissions, heat recovery systems are the next evolution of HVAC, transferring and managing rather than creating heat, and through efficiency and performance, provide economic value, better operation buildings, and ultimately better occupancy comfort.

## APPENDIX E

- Electrification is the “road ahead” for deep decarbonization in California
- Buildings (HVAC) are the best first place to begin reduction in natural gas
- Managed energy systems integrate onsite solar PV, energy storage, advanced HVAC
- Electric Vehicle (EV) infrastructure is integral to decarbonization of the energy system

### 12. All electric buildings in new construction

California has already begun the transition to building electrification through the design and construction of all electric buildings (new and replacement buildings). On college campuses, which often comprise hundreds of buildings and construction that is 50 years old, and sometimes much older, replacement of a building with new construction is a better choice than renovation. New buildings are designed as a “blank slate”, and need not follow the exact architecture of older construction, allowing for greater use of high performance glazing and daylighting, and often employing advanced energy infrastructure including rooftop solar PV, and ground source heat pumps (NASA-Ames Sustainability Base, building N232, completed in 2012.

(and new construction of the nearly all electric 50,000 sq-ft Foothill-De Anza district Sunnyvale Campus in 2016, and the all electric (similar sized) new district office, commissioned in late 2019).

These all or nearly all electric buildings have very low Energy Use Intensity (EUI) of 40,000 BTU/sq-ft annual, and are often supplied with low carbon electricity through Power Purchase Agreements (PPA). Compared to adjacent buildings with EUIs of 100,000 BTU/sq-ft annual, using standard grid electricity, these buildings have a GHG output that is 1/100th of the older buildings on campus. Over time, new construction will replace older buildings, but that could take decades, and the opportunity to replace central plant HVAC with heat recovery systems, including local solar electric power, and energy storage to maximize storage of solar PPA energy, is now. As described in the section on thermal (total energy) microgrids, the combination of a number of elements including campus level Building Management Systems (BMS) with energy storage and microgrid controllers, offers the ability to maximize the use of low carbon electricity, either from onsite sources, or through a solar PV PPA. High performance buildings are also competitive in cost with traditional construction, but offer significant operational savings from lower energy use, and often have nearly zero reportable GHG emissions.

- All electric buildings are a path to decarbonization, no natural gas used anywhere
- Energy Use Intensity (EUI) is significantly lower ( < 40%) than existing buildings
- Energy efficiency measures including solar PV, glazing and daylighting built into design
- Electricity from onsite solar PV and solar energy PPA lead to zero reportable emissions

### 13. Support for electrification of transportation

Electrification of transportation is actually a larger component of decarbonization than buildings, and will prove to be a harder challenge than electrification of buildings. Electric vehicles are a

## APPENDIX E

significant fraction of California vehicle purchases, as much as 10% of new vehicle purchases, and a very high number of vehicles on California Community College campuses.

Parking lot surveys at Foothill-De Anza district found (unduplicated) 75 EVs at Foothill College and ~ 90 at De Anza College. 10 % of F/T faculty at one college drives an EV (PHEV or BEV) and EVs were seen in 3% of parking spots at Foothill College (with some duplication). A number of models have been used to estimate the ratio of EVSE to EVs (PHEV or BEV), the ratio can be 3 or 4 to as much as 10. As an example, for 75 electric vehicles observed at Foothill and 100 EVs at De Anza, having 25 EVSE chargers on each campus should provide adequate access to charging, assuming coordination among users.

Supporting electric vehicles, especially Battery Electric Vehicles (BEV), at college campuses assists a large segment of the population to have a “destination anchor” for EV charging. EV growth projections suggest that EV drivers could double or triple by 2025, using the survey numbers from our two campuses, leading to 150 to 300 EVs on campus in 5 years. Using a number halfway between 3-4 and 10 EVs per EVSE, suggests that 30 to 50 EVSE chargers on a modest sized campus is a reasonable target number for 2025. The “bottom up” approach can also be checked against a “top down” approach, where each parking lot of reasonable size and solar PV deployment of 250 to 500 kW per parking lot, has 4 - 8 EVSE located near inverters.

Such a top down approach leads to ~ 48 to 50 chargers on a modest sized parking lot, and power bus architecture located near solar PV can easily be extended to 8-12 EVSE per lot. Ideally, each EVSE should have at least 10 kW solar PV allocated to a carbon free energy “budget” for EV charging. Solar deployments larger than that can also provide energy for electric HVAC services. Progress in electrification of transportation requires investment in infrastructure, including additional onsite solar PV and electrical storage to minimize spikes in demand.

Electric vehicles will only grow in popularity, and by 2030 could represent one in three new cars on campus, by 2040 every other car will either be all electric or an electric hybrid of some type. Planning for a future with so much electrical demand, integrated into the larger power grid, is difficult to imagine. Autonomous vehicles will additionally play a significant role in transportation for our students and employees. One thing is certain, if we can't control and eventually limit the use of petroleum, we will not be able to manage and reduce radiative forcing from GHGs

- Electrification of transportation is a bigger challenge than electrification of buildings
- EV adoption is significant in 2019, most colleges have at least 100 EVs on campus
- Automakers are expected to release dozens of new electric models in 2022-23
- Growth will double or triple by 2025, hundreds of EVs will be parked on our campuses
- Support for EV charging enables BEV drivers to get home, PHEV to stay on electric
- EVSE is expensive, electric infrastructure needs to be bolstered, locate near solar PV
- Power (kW) and energy (kWh) need to be thought through, EVSE has to be metered
- A future with electrified transportation, and autonomous vehicles, is difficult to imagine

14. Thermal (total energy) microgrids, putting it all together

## APPENDIX E

The concept of a thermal (total energy) microgrid as applied to college campuses is an integrated energy system, including onsite solar PV, cogeneration, electrical and thermal energy storage, utility energy, often including solar Power Purchase Agreements (PPAs), and a microgrid controller to manage energy flows, especially generating, storing, and distributing energy (see figure below from EDF report). Thermal microgrids integrate campus heat recovery HVAC systems into the microgrid foundation, and especially the ability to utilize electricity produced from solar and wind. Advanced energy systems include demand side management through building management systems, and support for EVSE (EV charging).

- Distributed energy generated behind the meter (solar PV and cogeneration)
- Electrical and thermal energy storage
- Heat recovery HVAC linked to solar generation, energy storage, and solar PPA
- EVSE (EV charging) is a growing and integral load also linked to solar energy

### 15. Conclusions and recommendations

California's Community College system is integral to, and a perfect proving ground for, the path to decarbonization through electrification of buildings, and development of Renewable Energy (RE) projects supplying emission free energy to large customers for extended time (contracts). California's 115 Community College Districts include a significant number of campuses with building and HVAC infrastructure that is prime for upgrading to electric heat recovery systems, which are not only more efficient, their energy can come from zero carbon emission sources. The cost and complexity of these projects is non-trivial, and presents engineering, financial, and logistical challenges, which could delay or prevent individual colleges and districts from going forward with these projects, and perhaps settling for "replacement" rather than "upgrade", locking in carbon emissions for 15-20 years further. Through a coordinated effort, California can develop a holistic approach to identifying campuses and infrastructure prime for upgrading, assist in (matching) funding, provide a centralized source of knowledge for planning, designing, engineering, deploying, and perhaps even managing the next generation of HVAC systems. Community Colleges, because of their complexity, and also the large amount of land (parking lots) and other available space, provide opportunities for combining large scale solar PV installations with onsite energy storage, feeding into a thermal microgrid, combining onsite emission free electricity, with a thermal / electric heat recovery system. This is the path forward to decarbonization, and California Community Colleges can lead the charge in this transition!

- California Community Colleges have significant reach and visibility in our communities
- CCCs have traditionally been "forward looking" in investment in new energy technology
- Solar, LEED/ZNE, EV charging, building electrification, advanced energy management
- Many colleges have 50+ year HVAC infrastructure, ideal for upgrading and replacement
- Costs are significant, and support from the State is essential to advance these projects

### 16. References



## APPENDIX E

Technical references for heat recovery and decarbonization

Department of Energy - <https://www.energy.gov/energysaver/heat-and-cool/heat-pump-systems>

A Roadmap to Decarbonize California Buildings

<http://www.buildingdecarb.org/resources/a-roadmap-to-decarbonize-californias-buildings>

The Path to 2050 and Deep Decarbonization -  
<https://www.planning.org/events/activity/9136743/>

### 17. Appendices

EDF modeling project - Foothill College partnered with Electricity de France (EDF) labs in Los Altos to model the central HVAC plant as an electric heat recovery system.

Technical content, engineering diagrams, financial estimates, supporting white paper content

TOTEM - **T**ool for **O**ptimization of **T**hermal and **E**lectric **M**icrogrids

Diagram SESI Thermal Microgrid

Diagram Foothill College Thermal Microgrid

GHG emission reduction estimates

Project tasks for preparedness

Dissemination paths (SVCE Innovation Grant)

Strategic Energy Innovation - Curriculum Development

FHDA Decarbonization Plan (DRAFT)

18. Authors and contributors, Sonika Choudhary (EDF), other EDF associates (Paul Bresler?), Robert Cormia and Jim Kozelka (Foothill-De Anza district), Chris Hansen (Foothill College), and Alice Sung (Green Bank Associates)

## APPENDIX E

### Appendix - Electricity de France (EDF) Labs / Foothill College Heat Recovery Modeling Project

In early 2019, Electricity de France (EDF) labs in Los Altos, California, provided seed funding for a decarbonization modeling project at Foothill College. The goal of the project was to develop a heat recovery opportunity model, specify appropriate infrastructure for modernization of the central plant, and estimate project and operational cost, operational savings (and payback period), and projected GHG emissions reduction.

The project was a test case for developing a practice to organize, analyze, and prepare thermal data from heating and cooling in the central plant, to determine if the campus would be a good opportunity for a heat recovery system. For a number of weeks, data was extracted from meter logs, analyzed for integrity, and then entered into various computer applications for visualization.

One specific tool, TOTEM (**T**ool for **O**ptimization of **T**hermal and **E**lectric **M**icrogrids) was developed especially for analysis of thermal data, and developing a profile of simultaneous heating and cooling, which represents the heat recovery opportunity. The project required significant effort to locate data logs for meters, as well as troubleshoot existing meters, and “fill” missing data through analysis of similar time periods in adjacent years.

Once the data is organized and ready for analysis, current utility bills are needed to provide rates (tariffs) for energy costs, and additionally onsite generation (solar PV and cogeneration) are added into the model. Finally, dispatchable loads including EV charging are integrated into the model. TOTEM works fairly quickly to specify the components needed for the future central plant, including HVAC components, thermal and electrical energy storage, and options for different solar PV configurations. Solar PPA contracts are also integrated as a utility input.

The current state of the project has provided a draft model for a thermal (total energy) microgrid comprising a central HVAC plant using an electric heat recovery system, with thermal and electrical energy storage, additional solar PV to provide low carbon energy for HVAC, and EVSE (EV charging). The model estimates current and future energy use and cost, a estimate of capital equipment cost, including upgrades to the thermal hydronic network, and estimated GHG reduction. From these projections, an estimated cost per ton of CO<sub>2</sub> reduced was made.

New capital equipment:

- Heat pump / HVAC
- Thermal storage
- Electric energy storage
- Additional solar PV (500 kW)
- Microgrid controller
- Extension of hydronic system

Energy and costs details are detailed in supplemental material

## APPENDIX E

TOTEM Output for design of a Total Energy / Thermal Microgrid at Foothill College

Output of TOTEM for Heat Recovery System, Electrical and Thermal energy storage

Selected design:

Thermal generation

Heat recovery chiller 540 tons 9 units

Electric chiller 0 tons 0 unit

Hot water generator 0 kBTU/hr 0 unit

Multistack ARA VersaTemp combined heating and cooling system

60 tons / unit maximum of 20 units, \$75,000 per unit, estimated cost \$4.5 million

Storage

Electric storage 1,114 kWh continuous variable

Hot water storage 23,357 kBTU continuous variable

Chilled water storage 2,905 ton-hr continuous variable

DER generation

Photovoltaics 500 kW nominal 2000 250W panels

Existing capacity 1.5 MW, recommended additional capacity 0.5 MW, total system 2 MW

Cost of solar electric parking lot installation @ \$7.5 / watt installed (includes racking and inverters, upgrades to the electrical system, and minor improvements to the parking lot)

Cogeneration capacity: 4 x 60kW Capstone microturbines, total nameplate capacity 240 kW, real power output ~ 200 kW Natural gas consumption is ~ 200,000 therms a year

Electric energy storage of ~ 1-2 MWh, 250 kW to 500 kW discharge for 2-4 hours, estimated cost of ~ \$750/kWh (installed), total project cost ~ \$1.5M with microgrid controller & analytics

Microgrid controller - for monitoring onsite generation and power management to buildings, energy storage, and time of use optimization of utility energy. (No equipment specification).

Electric Vehicle Supply Equipment (EVSE) future capacity ~ 25 chargers with an estimated power demand of 5 kW (blend of 4 kW PHEV and 7.5 kW BEV). Annual energy = 125,000 kWh

Note that we may have additional "solar parking" (~ 250 kW ?) installed for the EVSE, either as "banks of solar / EVSE" or EVSE located near existing and future solar PV deployments.

## APPENDIX E

Thermal Microgrids: Technology, Economics and Opportunity - EDF Labs December 2017

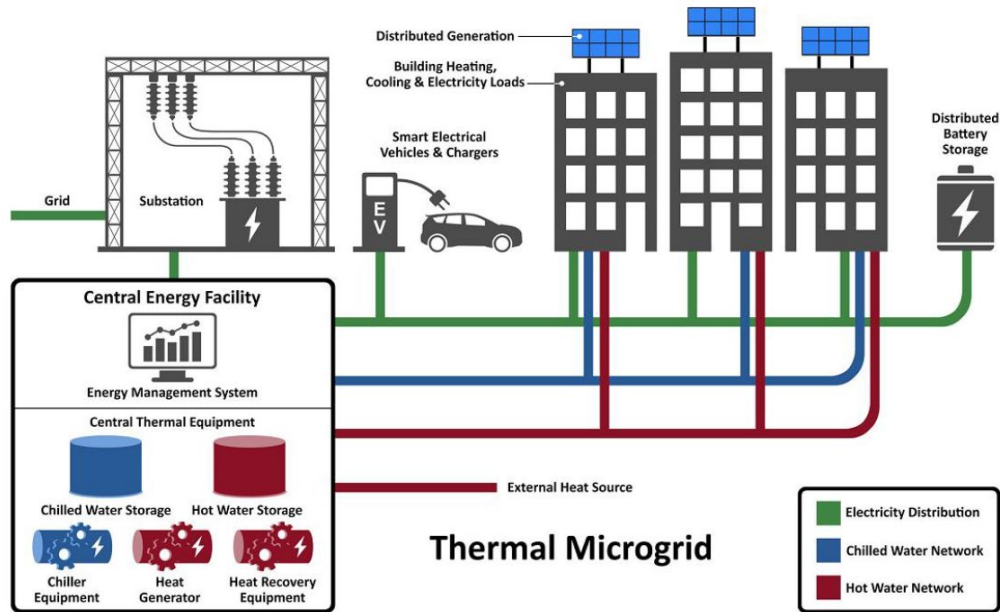

## Future Energy System Model

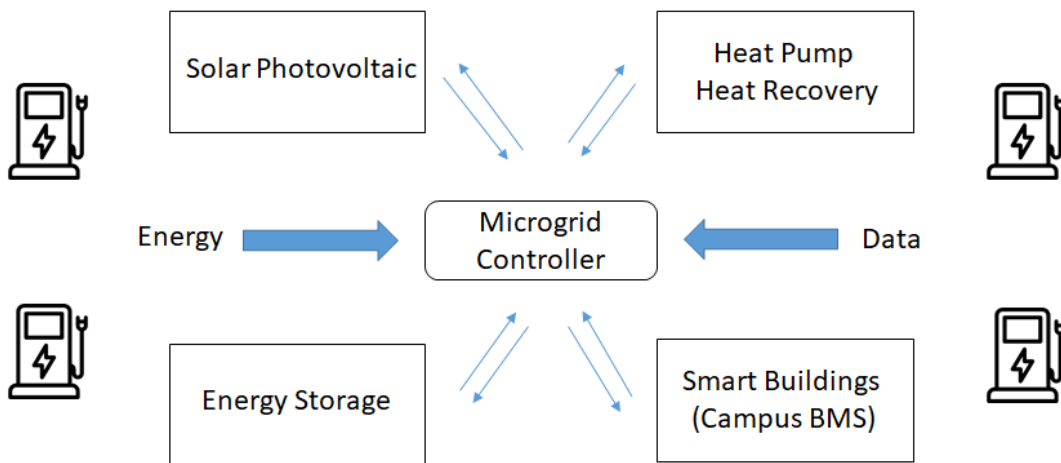

### Future microgrid energy architecture with “managed energy” process

Foothill College energy model (presented in Foothill-De Anza district path to decarbonization 9/25/2019)

## APPENDIX E

### Appendix - GHG savings estimates for Foothill College in 2025 (projected)

From the 2009-10 GHG inventory:

~ 4.5 M kWh electricity @ 1 lbs CO<sub>2</sub> per kWh =  $4.5 \times 10^6$  lbs CO<sub>2</sub>

450,000 therms natural gas @ 11.7 lbs CO<sub>2</sub> per therm =  $5.3 \times 10^6$  lbs CO<sub>2</sub>

Total carbon dioxide in 2009-10 ~  $10 \times 10^6$  lbs CO<sub>2</sub>

Replacing the central plant HVAC natural gas boilers with electric heat recovery system reduces natural gas use to cogeneration, ~ 200,000 therms @ 11.7 lbs CO<sub>2</sub> per therm =  $2.3 \times 10^6$  lbs CO<sub>2</sub>. From the 2009-10 base of ~  $9.8 \times 10^6$  lbs CO<sub>2</sub> this is a reduction of ~ 75%

The key elements Foothill-De Anza district central plant / decarbonization plan comprise:

1. Purchase of carbon free electricity
2. Replacing natural gas boilers in central HVAC plant
3. Additional onsite solar PV for HVAC and EVSE
4. Electrical and thermal energy storage
5. Support for EVSE (EV charging)
6. Microgrid controller / energy management system

Infrastructure and operational costs for the system include:

1. Replacement of central HVAC - \$1M
2. Upgrading of hydronics - \$2.5M
3. Upgrading building HVAC - \$500K
4. Additional 500 kW onsite solar PV - \$2.5M
5. Electrical energy storage - \$1M
6. Thermal energy storage - \$1.5M
7. EVSE (EV charging) - ~ \$500K
8. Microgrid controller and analytics - ~ \$750K
9. Project design (ESCO) - ~ \$500K
10. Project deployment - \$1.5 M
11. Commission first year ~ \$250K, \$125K-\$150K MRO per year

Estimated capital cost of project \$12.5 M

Difference in operating cost (~ \$125K/yr)

20 years simple payback ~\$20M / 20 years ~ \$1M per year

~ \$750 per metric ton CO<sub>2</sub> reduced (reduction of ~ 2.9 M pounds / 1,330 tons CO<sub>2</sub> per year)

Operational basis, ~ \$125 -150K/yr (incremental) / 1,330 tons per year ~ \$100 / ton CO<sub>2</sub> reduced

## APPENDIX E

Appendix: Key activities required for heat recovery project readiness (this is a work in progress)

1. Have natural gas and electricity utility bills organized and analyzed
    - a. Determine therms used for heating, and cogeneration, if applicable
    - b. Calculate BTU per sq-ft heating and kWh per sq-ft for all uses
    - c. For electricity, gather kW and kWh interval data for an entire year
  2. Organize and analyze onsite energy generation
    - a. For every onsite generation source, solar PV, cogeneration
    - b. Gather and organize 15-minute interval data (kW) and calculate kWh
    - c. Combine solar PV data, including 15-minute kW and kWh all arrays
  3. Integrate all electricity and natural gas data, develop an energy balance model
    - a. Convert kWh to BTU (3,412 BTU / kWh)
    - b. Therms are in BTU (100,000 BTU/therm)
    - c. Separate therms into heating, cogen, and cogen waste heat
  4. Organize thermal HVAC plant data if it exists
    - a. Organize meter data (heating and cooling BTU)
    - b. Natural gas use and BTU transfer
    - c. kWh use and cooling BTU transfer
  5. Develop a heat recovery opportunity model
    - a. Organize heating and cooling data into a BTU / interval model
    - b. Display heating and cooling profiles, determine overlap
    - c. Quantify the overlap, prepare data for heat recovery sizing
  6. Develop a GHG inventory for electricity and natural gas
    - a. Use carbon intensity of electricity from power mix
    - b. Use 11.7 lbs CO<sub>2</sub>/therm for natural gas (cogen and heating)
    - c. Estimate GHGs by end-use activity, and what can be reduced
  7. Develop a first draft of GHG reduction opportunities
    - a. Switching to low carbon or emission free electricity
    - b. Replacing natural gas boilers with electric heat pumps
    - c. Add additional solar PV to provide energy for HVAC
  8. Develop a plan to replace one or more natural gas boilers with heat pumps
    - a. Take the heating BTU transfer from the thermal data (section 4 and 5)
    - b. Enter the heating data into a tool (e.g. TOTEM) for sizing the unit
    - c. Estimate power, energy, and operating cost from model parameters
  9. Develop a 5 year EVSE (EV charging) plan
    - a. Do a physical count of EVs on campus
    - b. Do a survey of employees and students
    - c. Calculate power and energy requirements
  10. Develop a draft of a thermal microgrid campus energy system
    - a. Add all energy inputs (electricity and natural gas), utility and onsite
    - b. Add solar PV, electrical and thermal energy storage, heat recovery, EVSE
    - c. Estimate capital and operating costs, energy and GHG savings
  11. Prepare an RFI (Request For Information) and post (share) decarbonization goals
- Appendix Dissemination: Silicon Valley Clean Energy (SVCE) innovation grant

## APPENDIX E

Alice Sung (Greenbank Associates)

Goal is to create awareness about heat recovery systems in deep decarbonization of the California Community College system, and support a path for building a heat recovery system at Foothill College, as a potential case study.

SVCE - Aimee Bailey

Scope of work:

Work together to write policy documents, guidance, pieces of procurement design and construction, to speed a master planning and strategic approach, where to start. Overall master plan for decarbonization

1. Overall master plan for decarbonization
2. Campus assessment and readiness
3. Path to approach project description (RFI/RFQ)
4. Engagement of vendors
5. Project management

Language in an RFQ for a design build tiger team. It will take effort at the State level to understand how to support California community colleges in planning, preparing, organizing, leading up to a decarbonization project.

Incremental or it could complete. That could be a question for engineers,

Problem statement: decarbonization is complicated, and above the level of most (or any) community college. A toolkit is methodology or framework and growing body of work, creating a roadmap for decarbonization, that includes early adoption, before mature industry solutions exist. Phase 1 identifies the problem. Creating a process to catalyze decarbonization at the CCC level, a phase 1 approach, that will create awareness. The roadmap could be very similar for the two different sets of schools. Answers may be different, but the process could be similar:

Preparedness:

Energy balance modeling, electricity, natural gas, heating, and cooling. Availability of onsite solar, and/or emission free electricity contracts. Support / commitment letter.

Thesis project (goal) would be to document the process that we are going through to develop a plan to prepare Foothill to decarbonize using advanced energy systems architecture / solutions. Lay the groundwork for continuing our project goal (commitment) of deep decarbonization.

Appendix: Education

## APPENDIX E

Robert Cormia presented a short lecture on decarbonization and thermal microgrids to Strategic Energy Innovation (SEI) at a meeting of Climate Corp fellows in Santa Rosa. The presentation was well received, and SEI offered Robert an opportunity to develop curriculum for Climate Corp on the topic of decarbonization. Robert began work on the project in December 2019.

1. Introduction - complex energy systems, decarbonization, and transitional strategies
2. Foundational review of energy systems
3. Transition from utility to distributed generation
4. Energy versus power, the reality of demand charges, and solar PV production curves
5. Integrating energy storage, analysis and management of complex energy profiles
6. Exit natural gas, the rise of building electrification, and heat recovery systems
7. Heat recovery primer
8. Heat recovery assessment toolkit
9. Electric Vehicle (EV) charging
10. Thermal microgrids, total / managed energy systems
11. Decarbonization paths, how do we do this?
12. Partners and projects, building your campus energy future

### Target audience

1. Students in certified energy management (CEM) certificate programs
2. Internship training in campus energy systems, especially HVAC central plants
3. Technician training - introduction to heat recovery

### Curriculum provided

1. Overview of existing onsite energy technology (solar PV and cogen)
  - a. Existing solar PV curriculum
2. Introduction to microgrid concept (onsite energy generation, energy storage, demand side management, microgrid controller, solar PPA and utility interface)
  - a. Block diagram, definitions, design of small microgrid systems
3. Fundamentals of electric heat pump systems (thermodynamics of heat exchange)
  - a. New curriculum to be shared with engineering faculty
4. Replacement of natural gas boilers with electric heat recovery systems
  - a. Commercial datasheets, heat recovery opportunity toolbox
5. Concept of a thermal microgrid
  - a. Component diagram of microgrid with heat recovery, hydronic systems, additional onsite solar PV, solar PPA, energy storage, microgrid controller
6. Case studies of thermal microgrid modeling, design, and deployment
  - a. Stanford SESI (central plant), Foothill College (EDF study)
  - b. Vendor “total energy solutions”, managed energy microgrids (EDF)

Appendix: Foothill-De Anza district Decarbonization Plan (DRAFT) - Robert D. Cormia -  
November 2019



## APPENDIX E

Foothill De Anza Community College District (Foothill-De Anza district), has a long history and commitment to environmental leadership, sustainability, and investment in clean energy technology. This includes infrastructure improvements, LEED certified buildings, and extensive onsite solar energy. On September 17, 2018, Chancellor Judy Miner committed Foothill-De Anza district to an 80% reduction in Greenhouse Gases (GHGs), during a decade of decarbonization, from 2020-2030. This goal would be achieved through a combination of purchasing clean electricity, replacing natural gas HVAC systems with electric heat recovery infrastructure, and support for Electric Vehicle (EV) charging. These initiatives take time, planning, and resources, combined with commitment, strategy, and management of multi-year projects that are technically complex. These projects are also embedded in the larger evolution of modern energy systems, and the reinvention of modern electric utilities. This executive summary will outline 5 key elements of the Foothill-De Anza district decarbonization plan, and a path to achieve our goals in the next decade.

1. Purchase of clean electricity (solar PPA)
2. Electric Vehicle (EV) charging support
3. Replacing natural gas HVAC with electric heat recovery systems
4. Developing a thermal microgrid architecture
5. Employing advanced energy management tools / processes

College districts face a number of challenges and opportunities in a path to decarbonization, including funding, planning and expertise, and the ability to manage and integrate complex engineering projects. Foothill-De Anza district, and specifically Foothill College, working with Electricity de France Innovation Labs in Los Altos, CA, developed the five part plan based on EDF lab's experience working with Stanford University's Energy System Innovation (SESI), the City of Palo Alto, and EDF's experience as a global thought leader in decarbonization.

### Purchase of clean electricity (opportunity 2020)

Purchasing electricity sourced from zero carbon emission primary energy (solar, wind, and hydroelectric) is the easiest, fastest, and least expensive step in decarbonization, with significant reduction in reportable GHG emissions, with low incremental cost. Purchasing electricity through cooperative buying collectives makes it even easier and more affordable. The incremental cost for Foothill-De Anza district to switch to a renewable energy sourced contract is roughly \$100 a day, and reduces reportable emissions by 3,000 tonnes of carbon dioxide per year, or \$12.5 per tonne CO<sub>2</sub> avoided. As discussed later, developing larger thermal microgrids like SESI may require investment in a solar project, but a purchasing cooperative can lessen the difficulty of this task. (Stanford invested in a long-term solar PPA project for a significant fraction of their electricity, and will "own" the output of the project for ~ 20 years). Plans for purchasing clean electricity are currently being discussed, with a one-year bridge contract available in early 2020, and a solar Power Purchase Agreement (PPA) available in mid-2021.

### Electric Vehicle (EV) charging support

## APPENDIX E

Beginning in 2013/14, Foothill-De Anza district installed 10 EVSE charging stations at De Anza College. These chargers experienced difficulty from misuse, software issues, and a lack of support from the vendor (no maintenance contract). In 2019/20, these chargers will be replaced with a more robust solution, including a maintenance contract. Concurrently, a small number of chargers will be installed on the Foothill College campus, primarily at the new District Office. An extensive survey of vehicles in parking lots, and online survey of staff (and later, students) revealed a significant number of Electric Vehicles (EVs), operated by staff and students. An early model was developed to support EV charging based on a 1:5 ratio of EVSE/EV, where ~ 20 EV chargers would be located at Foothill, ~ 25 additional chargers at De Anza, 2-3 at Sunnyvale campus. Initially operating at ~ 4-5 hours a day, at ~ 5 kW (average demand for level 2 charging) the additional power and energy demand would be ~ 100 kW and 80,000 kWh per year, and at De Anza, ~ 125 kW and 120,000 kWh per year. This would equate to about 1% of annual electrical energy use, which could be offset by additional parking lot solar PV, which would also accommodate the transition from natural gas to electric heat recovery systems.

### Replacing natural gas with electric heat recovery systems

After switching to carbon free electricity, the remainder of campus emissions arise from natural gas for heating buildings, and cogeneration of heat and power for the swimming pool. Currently, ~ 60% of Foothill-De Anza district GHG emissions are assigned to natural gas, with about 40% from cogen (cogeneration of heat and power) and 60% from space heating. The Sunnyvale Campus was designed as a nearly all electric building, utilizing electric heat recovery and thermal storage for HVAC. The new District office is all electric, with a solar PV capable roof. Beginning in 2019, Foothill College undertook a joint project with Electricity de France Innovation labs in Los Altos, to develop a model for a heat recovery system, similar to Stanford Energy Systems Innovation (SESI), to replace the natural gas fired boilers and traditional chillers in the central plant. This project, in progress, has shown the potential for heat recovery to lessen heating loads, as reduce the campus's natural gas use by at ~ 60%. The modeling effort will yield a draft specification for the central plant replacement with electric heat pumps, which will be included in a future capital bond (March 2020). If funded, the project would likely be completed ~ 2025.

### Developing a thermal microgrid architecture

Distributed generation has long been part of the Foothill-De Anza district energy strategy, including significant onsite solar PV, as well as cogeneration of heat and power. Onsite energy production provides nearly half of Foothill's electric energy needs, and about a third of De Anza's electricity needs. As the District plans to replace natural gas with electric heat recovery systems, and as EV charging needs grow, each campus will need more power (kW) and energy (kWh), especially as utilities enforce time-of-use tariffs, as well as need integrated demand side management, to both balance an increasingly decentralized power system, as well as distribute increasingly larger flows of solar energy, especially as Renewable Portfolio Standards (RPS) surpass 33% and grow to 50% by the end of the decade. Energy storage is the technical mediator between solar energy over generation, and peak shaving (demand management).

## APPENDIX E

Thermal microgrids, a concept developed by Electricity de France, in concert with Stanford (SESI) to describe the combination of electric microgrids, heat recovery and thermal energy storage, electric energy storage, EV charging, and a microgrid controller, with the ability to monitor and manage campus power demand, local power generation, and interface (and integrate) with the local distribution grid, and larger transmission system, where large utility scale generation (the source of Power Purchase Agreements) exist. Thermal microgrids generate, store, manage, and distribute electrical and thermal energy, in a highly integrated manner, with clean energy electric inputs, merged with local onsite solar generation, and blended utility energy. Thermal energy microgrids are more complex to develop, more complicated to operate, and requires rigorous modeling and design. New buildings with electric heat recovery (and thermal energy storage), onsite solar PV, electric energy storage, and integrated microgrid controllers with demand side management, are more straightforward to design, then the comprehensive replacement of natural gas in large-scale central plant designs.

Employing advanced energy management tools / processes

Operating a thermal (total energy) microgrid, i.e., a “managed energy system” requires sophisticated integrated energy and data management tools, powered by machine learning systems that build experience into active energy management. This includes buildings, central plants, energy storage, EV charging, and Integrated Demand Side Management (IDSM) which ties local managed energy systems into the surrounding electric power distribution grid. Energy management tools will likely evolve as part of the new system architecture, as Stanford (SESI) has done with Johnson Controls. Advanced energy management provides benefits in the cost of energy, alleviating congestion during peak demand, maximizing the distribution of solar energy generation, alleviating curtailment, and ensuring the EV charging does not cause excessive power and energy use, especially during peak demand.

Together, these five trends will unite clean sources of electricity with modern electric building systems, thermal energy storage, active energy management, and support for electric mobility. Foothill-De Anza district is committed to a decade of decarbonization, beginning with the purchase of clean electricity, followed by a thoughtful budgeting of funding for an electric heat recovery / thermal energy HVAC infrastructure replacing natural gas fired boiler systems. It is imperative that Foothill College finish its collaborative study with EDF, to provide a reasonable cost estimate for a capital bond measure, the most likely source of funding for the infrastructure development.

This decarbonization plan will be further described in the Foothill-De Anza district facilities and energy master plan. We also plan to coordinate our energy system planning and development process with other community colleges of similar age and infrastructure, also facing the challenges and opportunities of decarbonization. This is especially important in helping California meet accelerated 2030 - 2050 decarbonization goals, including electrification of transportation.

# Thermal Microgrids: Technology, Economics and Opportunity

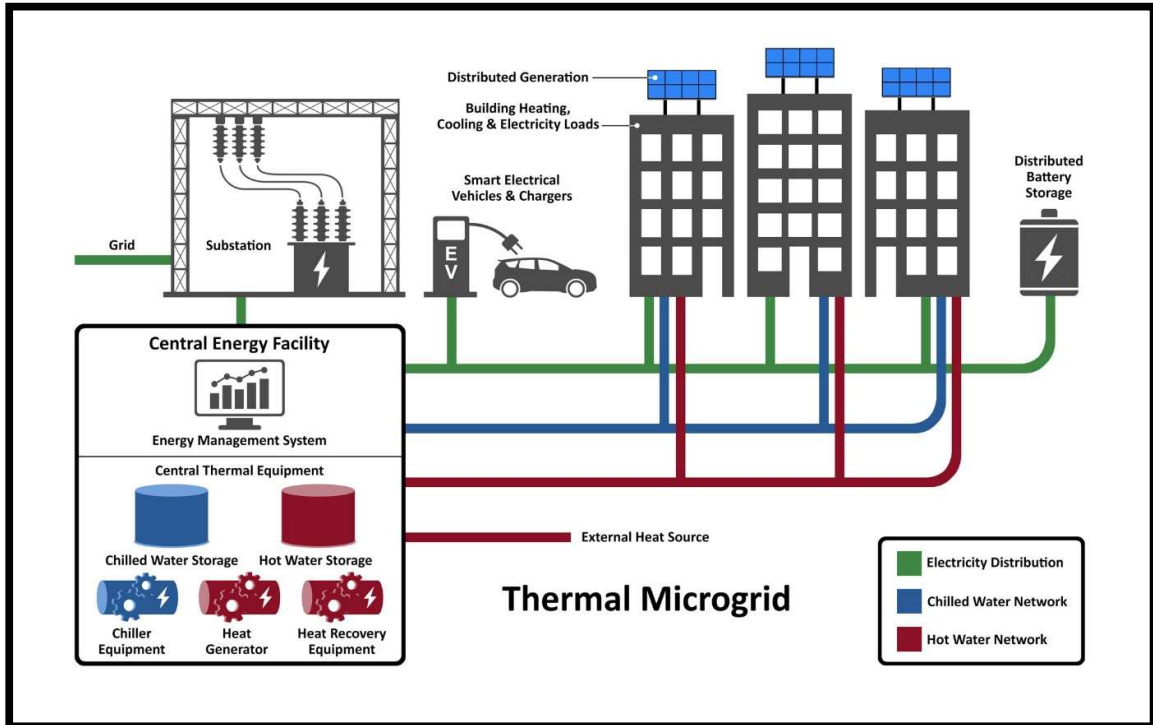

EDF Innovation Lab

Aimee Bailey, PhD  
Stephanie Jumel, PhD

December 2017

Funding provided by:



## About this Report

This report was completed as a part of a collaboration between EDF Innovation Lab, Stanford University and the City of Palo Alto Utilities for the project *Leveraging Experience from Stanford and EDF to Develop Information and Tools for Thermal Microgrid Feasibility Assessments*, funded by the American Public Power Association (APPA) Demonstration of Energy & Efficiency Developments (DEED) program. The project objective is to provide information and tools to support municipal utilities in evaluating the feasibility of deploying thermal microgrids. Deliverables of the project include i) a white paper describing the technology, economics and market of thermal microgrids and comparing them to alternatives (this report); ii) a case study report describing the Stanford Energy System Innovations (SESI) project, in which their campus-wide cogeneration system was transformed into to renewable electricity powered heat recovery with low temperature hot water distribution; iii) a suite of tools for assessing technical and economic feasibility; and iv) two municipal case studies applying the tools to carry out feasibility assessments.

## Contact

For questions or comments regarding this report, please contact:

Aimee Gotway Bailey, PhD  
Principal Energy Analyst  
EDF Innovation Lab  
[aimee.bailey@edf-inc.com](mailto:aimee.bailey@edf-inc.com)  
p: +1 650-209-3904  
m: +1 650-284-9062

For questions regarding APPA's DEED program, please contact the program administrator:

Michele Suddleson  
DEED Program Director  
American Public Power Association  
[MSuddleson@publicpower.org](mailto:MSuddleson@publicpower.org)  
p: +1 202-467-2960  
m: +1 240-876-1519

© 2017 EDF  
EDF Innovation Lab  
4300 El Camino Real  
Los Altos, CA 94022, USA

### Reference:

Thermal Microgrids: The Technology, Economics and Opportunity; Report Nr. EIL-R-2017-1231, December 31, 2017, EDF Innovation Lab, Los Altos, USA

## Acknowledgements

First, the authors gratefully acknowledge funding from the American Public Power Association (APPA) Demonstration of Energy & Efficiency Developments (DEED) program and the ongoing program management support and guidance from Michele Suddleson, DEED Program Director.

In addition to the APPA, several individuals and organizations contributed to this white paper by providing their perspectives, expertise and feedback. The authors gratefully acknowledge the contributions of two stakeholder groups convened through the project.

**The Utility & Other Users Forum** (abbrev. “Utility Forum” or “Stakeholder Forum”) reviewed and provided feedback on the white paper outline and draft report to ensure applicability and transferability of the results to a broad audience. Utility Forum participants included representatives from the APPA DEED membership, California’s Investor-Owned Utilities (IOUs), community choice aggregator (CCA) community, and several commercial entities.

**Peer Reviewers** for the white paper were comprised of renowned industry experts representing multiple sectors (e.g. regulatory entities, non-profit organizations, private sector, etc.). Their contributions led to rigor and accuracy of the deliverables.

- ❖ Jeff Byron, former California Energy Commissioner
- ❖ Keith Dennis, National Rural Electric Cooperative Association
- ❖ Bertrand Guillemot, Dalkia (EDF Group)
- ❖ Jerry Schuett, Affiliated Engineers
- ❖ Robert Turney, Johnson Controls
- ❖ Joe Vukovich, Natural Resources Defense Council

The authors are responsible for the final content and any mistakes.

# Table of Contents

About this Report	2
Contact	2
Acknowledgements	3
Table of Contents	4
List of Acronyms	6
Executive Summary	8
1. Introduction & Background	10
1.1 What is a “Thermal Microgrid”?	11
1.2 Recent Trends Driving Interest in Thermal Microgrids	13
1.3 Goals and Objectives for Local Energy System Development	14
1.4 Summary of Opportunity	15
2. Technology Description	17
2.1 Central Equipment	17
2.1.1 Heat Sources	17
2.1.2 Cooling Sources	19
2.1.3 Thermal Storage	19
2.2 Thermal Network	20
2.2.1 Integrating Heat Supply into the Thermal Network	21
2.2.2 Thermal Network Piping	22
2.3 Building Interconnection Equipment	22
2.4 Building Heating and Cooling Equipment	23
2.5 Energy System Performance	23
3. Overview of Project Economics	24
3.1 Primary Fixed Costs	24
3.1.1 Central Equipment Costs	24
3.1.2 Thermal Network and Building Interconnection Costs	24
3.2 Primary Ongoing Costs	25
3.3 Other Costs	25
3.4 Synergies with Other Utility Services & Customer Needs	25
3.5 Comparison of Project Economics Across System Design	26
4. Feasibility Assessment	28
4.1 Pre-Feasibility Assessment for Thermal Microgrid Design	29
4.2 Methodology for Techno-Economic Feasibility Assessment	31
4.3 Key Feasibility Drivers	32
5. Assessment of Potential in the U.S.	34
 EDF Innovation Lab	 4

6. Utility Business Models for Thermal Services	36
6.1 Ownership & Governance Structure	36
6.2 Metering & Rate Structures	37
7. Conclusions, Outlook & Next Steps	39
Appendix A. Further Reading	40
Appendix B. Energy Technology Potential Assessment	41
B.1 Introduction to Technology Potential Assessments	41
B.2 Application to Thermal Microgrids	42



## List of Acronyms

Acronym	Term
AMI	Advanced Metering Infrastructure
APPA	American Public Power Association
BAU	Business as Usual
BTU	British Thermal Unit
CCA	Community Choice Aggregation
CCF	Centum Cubic Feet
CCHP	Combined Cooling, Heat and Power
CHC	Combined Heat and Cooling
CHP	Combined Heat and Power
DEED Program	Demonstration of Energy & Efficiency Development Program
DER	Distributed Energy Resource
DG	Distributed Generation
DHC	District Heating and Cooling
DOE	Department of Energy
DR	Demand Response
EIA	Energy Information Administration
ETS	Energy Transfer Station
GHG	Greenhouse Gas
GIS	Geographic Information System
GJ	Gigajoule
GW	Gigawatt
GWh	Gigawatt-hour
HHV	Higher Heat Value
HP	Heat Pump
HRC	Heat Recovery Chiller
HVAC	Heating, Ventilation, and Air Conditioning
IDEA	International District Energy Association

Acronym	Term
IEA	International Energy Agency
IOU	Investor Owned Utility
IRR	Internal Rate of Return
kW	Kilowatt
kWh	Kilowatt-hour
LCA	Life cycle assessment
LCOE	Levelized Cost of Electricity
MES	Multi-Energy System
MMBTU	Million British Thermal Units
MW	Megawatt
MWh	Megawatt-hour
NPV	Net Present Value
NREL	National Renewable Energy Laboratory
O&M	Operations and Maintenance
POU	Publicly Owned Utility
PV	Photovoltaic
PVC	Present Value Cost
SESI	Stanford Energy System Innovations
SHP	Separate Heat and Power
SPV	Special Purpose Vehicle
TWh	Terawatt-hour
UNEP	United Nations Environment Programme

## Executive Summary

Addressing global climate change is the single greatest environmental challenge and opportunity faced by humankind. Energy provided for transportation, agriculture, industry, and buildings has enabled the vast advancement of humanity, yet the way humankind is producing, managing and using energy is threatening its very long-term existence. This report provides information about energy usage specifically in the buildings sector, and outlines a practical pathway for providing energy to buildings in a sustainable and economic way. The report includes information on a case study of how this has already been implemented at scale, as well as providing tools to help others evaluate such systems for their buildings.

Based on multiple studies carried out across the energy community in numerous countries, the emerging practical and scalable pathway to sustainable building energy supply is the combination of electrification and clean energy, following economic and sustained application of energy efficiency efforts. This conclusion is driven by the relative techno-economic feasibility of decarbonizing the generation of electricity as opposed to the use of renewable natural gas or transitioning to non-carbon fuels such as hydrogen. Power and cooling of buildings, when electricity-based, is readily made sustainable upon decarbonizing the electricity source. Heating and hot water, on the other hand, is predominantly supplied by fossil fuel such as natural gas. Decarbonization heating and hot water therefore requires a switch to a different, non-fossil fuel powered equipment.

Building electrification, however, need not rely on electric resistance appliances alone: electric-powered heat pumps can help catalyze this technological transformation. Electric heat pump appliances are commercially available and even more efficient than electric resistance and natural gas appliances, which unlocks the technological and economic transition to an all-electric system for building energy supply. Furthermore, heat pumps are flexible in that they can be used both to harvest waste heat from existing building cooling processes (heat recovery) as well as extract heat from ground, water, or air sources to augment heat recovery when needed in winter when waste heat alone is insufficient to meet building heating and hot water needs.

Discussions of building electrification and supporting policies have been gaining traction, yet the primary focus is building-level appliance switch-out (i.e. switching from a natural gas to an electric water heater in a building). An alternative approach is to develop a decarbonized energy system that is optimized for a group of buildings. These district energy systems are networks of underground pipes carrying steam, hot, or cold water used to heat and cool buildings. District energy has many advantages compared to building-level alternatives, including economies of scale from aggregating a collection of loads from numerous buildings; waste heat recovery technologies that are not available or efficient at a building-level scale; and, load and resource diversity that enable optimized central equipment sizing and resultant enhanced efficiency. Deploying heat pumps via a district energy system, adding thermal energy storage, and using advanced energy management programs can increase the efficiency and system resiliency, and lower the cost of electrification such that it becomes the least cost alternative for long term building energy supply. Collectively these components can be thought of as a thermal energy microgrid, much in the same way the combination of on-site renewable electricity, electricity storage, and electric vehicles can be thought of as an electric microgrid. The concept of electric microgrids has gained much attention as of late, yet given that two thirds of total energy use in buildings is thermal while electricity is but one-third, greater attention should be focused on the opportunity.

This white paper explores district-scale electrification incorporating both electricity and thermal (heating and cooling) services via so-called thermal microgrids as a technical pathway for decarbonization. Stanford University's campus energy system is the inspiration of the thermal microgrid approached and used throughout the white paper to illustrate its potential for achieving environmental, economic and other requirements for local energy systems.

# 1. Introduction & Background

Addressing global climate change is the single greatest challenge and opportunity faced by humankind. The energy sector in specific must play a decisive role in enabling the successful transition to a decarbonized economy, given that energy generation and usage contributes disproportionately to historic and current global greenhouse gas (GHG) emissions. Within the U.S., buildings are responsible for approximately 40% of all energy usage and a third of emissions, a significant portion of which is from appliances burning natural gas and other carbon-based fuels for heating and cooking<sup>1</sup>. The continued use of carbon-based fuels in buildings is not sustainable unless either supplanted by sustainable biogas sources or coupled with carbon capture and storage (CCS). However, both biogas and CCS are more expensive, less efficient, and impractical at scale compared to electrification combined with clean electricity<sup>2</sup>. Therefore, substantial fuel switching in the building sector from fossil fuel to electricity - also called electrification - combined with continued electricity decarbonization and energy efficiency are required to achieve science-based GHG emissions reductions targets<sup>3</sup>. These are also the conclusions of the international energy community as shown in references cited throughout the report.

Discussions of building electrification and supporting policies have been gaining traction in some regions<sup>4</sup>, yet the primary focus is building-level appliance switch-out (i.e. switching from a natural gas to an electric water heater in a building). However, with increasing energy efficiency practices reducing building heating and cooling loads, it may be increasingly difficult to size equipment appropriately. One could alternatively take a district approach and develop a decarbonized energy system that is optimized for a group of buildings. In fact, in 2013, the United Nations Environment Program (UNEP) surveyed low-carbon cities worldwide to understand key factors for their success in achieving zero or low GHG emissions targets and increased integration of energy efficiency and renewable energy, and district energy was identified as a best practice approach for providing a local, affordable and low-carbon energy supply<sup>5</sup>. District energy systems are networks of underground pipes carrying steam or hot/cold water used to heat and cool buildings. Historically, district energy development accelerated in the late twentieth century to achieve higher primary energy efficiency when the systems relied on volatile, imported fossil fuels, and to combat urban air pollution from open coal fires and oil-fired boilers. District energy systems have many advantages compared to building-level alternatives, including economies of scale from aggregating a collection of loads from dozens of buildings; waste heat recovery technologies that are not available or efficient at a building-level scale; and, load and resource diversity that enable optimized central equipment sizing and resultant enhanced efficiency.

---

<sup>1</sup> U.S. Energy Information Agency; U.S. Environmental Protection Agency's "Inventory of U.S. Greenhouse Gas Emissions and Sinks: 1990–2015"

<sup>2</sup> California's Energy Future: The View to 2050, California Council on Science and Technology, May 2011; Williams, J.H. et. Al., The Technology Path to Deep Greenhouse Gas Emissions Cuts by 2050: The Pivotal Role of Electricity, *Science*, Volume 335, January 6, 2012; Pathways to Deep Decarbonization, Deep Decarbonization Pathways Project; Southern California Edison's The Clean Power and Electrification Pathway Realizing California's Environmental Goals (Nov 2017).

<sup>3</sup> Ibid.

<sup>4</sup> E.g. California

<sup>5</sup> United Nations Environment Programme, District Energy in Cities - Unlocking the Potential of Energy Efficiency and Renewable Energy (2015)

This white paper explores district-level electrification incorporating both electricity and thermal (heating and cooling) services via so-called thermal microgrids as a technical pathway for decarbonization. The objective of this white paper is to address the following questions.

- What is a “thermal microgrid”?
- What are the advantages and disadvantages of thermal microgrids compared to alternatives?
- What are the costs, GHG emissions impacts and water usage requirements compared to alternatives?
- What are the primary feasibility drivers?
- What is the potential of this technology in the U.S.?
- What business model structures could a municipal utility use for delivering thermal services via a thermal microgrid?

### 1.1 What is a “Thermal Microgrid”?

Figure 1: Illustration of a thermal microgrid

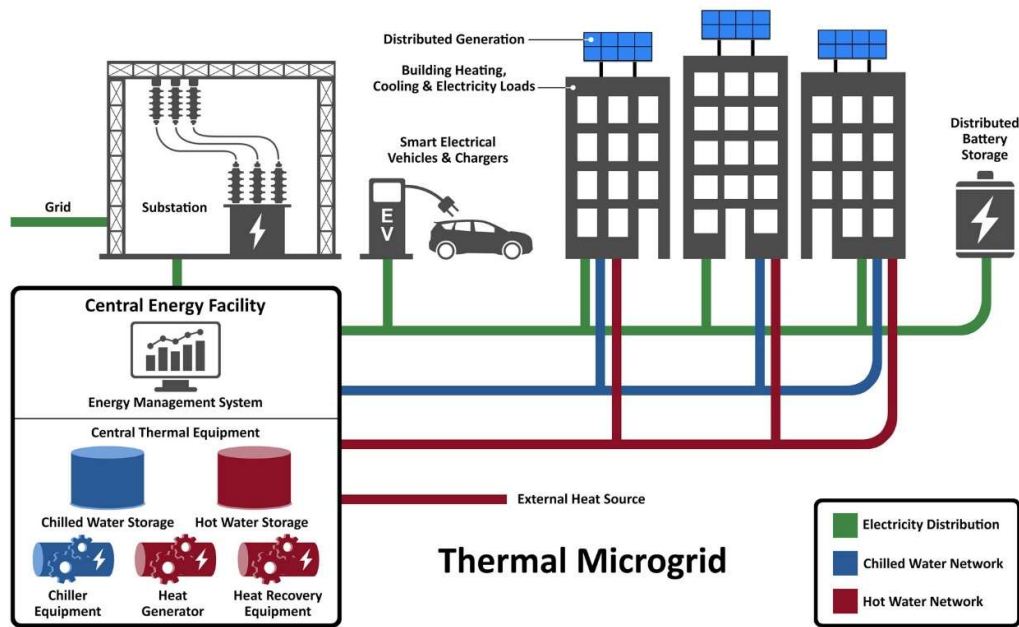

We define a thermal microgrid as follows.

*A thermal microgrid utilizes energy efficiency; renewable electricity powered heat recovery; thermal storage; and, advanced analytics and controls to provide co-optimized power and thermal services to a group of interconnected and controllable energy loads within a defined boundary.*

The concept is illustrated in Figure 1. The term *microgrid* is used to emphasize benefits associated with traditional electricity-focused microgrids, such as local renewable energy utilization, enhanced community resilience and reliability, systems-optimized control and dispatch of the collection of loads

and resources, and ability to meet critical loads during larger grid disturbances. The adjective *thermal* is added to denote that the microgrid also incorporates thermal services such as hot water, steam, and/or chilled water, in addition to electricity. Similar concepts have been introduced in prior studies, leading to a variety of other terminology, such as *energy district*, *multi-energy system*, *renewable district energy*, *multi-energy microgrid*, *energy microgrids*, *smart energy system*, and, most significantly, *4<sup>th</sup> generation district heating*<sup>6</sup>.

The hallmark of a thermal microgrid is the utilization of renewable electricity powered waste heat recovery as the cornerstone of the system design, enabled by low-temperature district heating networks and low energy buildings. At its heart, it is district scale electrification. This new category of district energy systems is inspired by Stanford’s recent transformation of their cogeneration system to a thermal microgrid, called Stanford Energy Systems Innovation (SESI)<sup>7</sup>. Burning fossil fuels in traditional district energy systems (e.g. combined heat and power) is replaced in thermal microgrids by advanced heat recovery utilizing heat pumps powered by renewable energy generation, either on-site or from grid-supply.

Table 1: Common energy system architectures

<b>Non-District Energy Systems</b>	<ul style="list-style-type: none"> <li>● <b>Building-Level</b> refers to an energy system configuration where buildings use electricity and/or gas to power on-site appliances for heating and cooling needs.</li> </ul>
<b>District Energy Systems</b>	<ul style="list-style-type: none"> <li>● <b>Separate Heat and Power (SHP, District Heating or District Cooling)</b> is a heat or cooling network that provides thermal services independently from the generation, management and provision of power.</li> <li>● <b>Combined Heat and Cooling (CHC)</b> is the use of a centralized system to simultaneously provide heat and cooling services for a district.</li> <li>● <b>Combined Heat and Power (CHP or cogeneration)</b> is the use of a centralized plant to simultaneously generate electricity and heat for a district.</li> <li>● <b>Combined Cooling, Heat, and Power (CCHP or trigeneration)</b> is the simultaneous generation of electricity, heat and cooling for a district.</li> </ul>

Most regions of the U.S. rely on building-level energy systems (Table 1, top). However, district energy systems are widespread across Europe and Asia, in addition to being prevalent in certain applications in the U.S., including specifically the central business districts of major cities, hospitals, university and corporate campuses, and military bases. There are several possible district energy system architectures, as outlined and defined in the bottom of Table 1. Traditional district energy in the U.S. uses fossil fuels as the main heating source and steam as the energy carrier. More recently, natural gas has emerged as a preferred fuel source given its availability, price, and reduced emissions, and hot

<sup>6</sup> Henrik Lund, Sven Werner, Robin Wiltshire, Svend Svendsen, Jan Eric Thorsen, Frede Hvelplund, Brian Vad Mathiesen, “4th Generation District Heating (4GDH) Integrating smart thermal grids into future sustainable energy systems”, Energy 68 (2014) p1.

<sup>7</sup> <https://sustainable.stanford.edu/campus-action/stanford-energy-system-innovations-sesi>

water is increasingly used as the energy carrier in place of steam. Heat distributed to buildings can be used for space and water heating, or it can be processed by an absorption chiller to be converted to chilled water for cooling.

The primary district energy system architectures represent traditional architectures largely developed with fossil-fuel fired technologies. Thermal microgrids could fall under Combined Heat and Cooling (CHC) or Combined Cooling, Heat and Power (CCHP), depending on whether there is significant renewable energy supply located on-site (CCHP) or sited remotely from utility-scale plants (CHC)<sup>8</sup>. Although there need not be power generation on-site, the power system is not separate and independent from the thermal network: there is substantial coordination and optimization between electricity usage and the thermal networks, primarily via centralized thermal storage, leading to enhanced opportunities for efficiency gains. For instance, thermal storage incorporated into SESI enables over 20% more waste heat recovery from the overlap in heating and cooling needs across campus. Moreover, thermal storage incorporated into a central energy facility design enables electricity load shifting from on-peak to off-peak periods, enhances reliability and resilience by being able to continue to provide thermal services during grid disturbances, reduces the installed chiller capacity requirements, and aids in the integration of local, variable renewable energy generation. None of these benefits can be realized with building-level systems or any energy system configuration where the operation of the electricity and thermal networks are largely decoupled.

Please see section 2 for greater detail of the description of the technologies underlying thermal microgrids and alternatives.

## 1.2 Recent Trends Driving Interest in Thermal Microgrids

Industry experts and prominent academics cite the “three D’s” as the primary drivers behind the current energy system transformation: decentralization, decarbonization and digitization<sup>9</sup>.

- **Decentralization.** The traditional paradigm of centralized power generation is being up-ended with the rise of customers and communities opting to take greater control over their energy production, management and use. Increasing adoption of behind-the-meter solar, smart thermostats and other building energy management devices enabled by exponentially decreasing costs and novel business/financing structures<sup>10</sup> combined with capacity and reliability considerations of the transmission grid are leading to a new, decentralized grid paradigm. Currently, distributed solar generation is estimated to reach 140 gigawatts (GW) by 2040, up from only 2 GW in 2010<sup>11</sup>.
- **Decarbonization.** Local and state governments across the U.S. have adopted climate goals and corresponding energy policies and regulations to promote decarbonization of the energy

---

<sup>8</sup>Traditional CHP and CCHP systems combust fossil fuel in an integrated process to generate electricity and heat simultaneously. In this white paper, CHP and CCHP need not refer to an integrated thermal process, but simply to co-locating power generation within the thermal microgrid boundaries and integrating it into the overarching system optimization, management and control.

<sup>9</sup> <https://energy.stanford.edu/from-directors/nurturing-innovation-during-strategic-inflection-point-global-energy>

<sup>10</sup> E.g. third-party ownership models for rooftop solar (lease and power purchase agreements)

<sup>11</sup> [https://www.eia.gov/outlooks/aeo/pdf/0383\(2017\).pdf](https://www.eia.gov/outlooks/aeo/pdf/0383(2017).pdf)



sector. Prominent policies include, for instance, renewable portfolio standards, incentives for distributed renewables deployment, and cap-and-trade programs for GHG emissions. These collective policies have supported renewables deployment, such that in 2016, renewables have grown to make up two thirds of all electricity capacity additions<sup>12</sup>.

- **Digitization.** Currently, nearly half of U.S. electricity customers have advanced metering infrastructure (AMI) (aka *smart meters*) - the backbone of the smart grid transformation - which represents a doubling of AMI deployment since 2010<sup>13</sup>. More generally, the increased deployment of low-cost sensors, advanced control technologies, and artificial intelligence is fundamentally changing every facet of the energy sector, from home thermostats to utility rate-making.

The same three drivers behind the larger energy system transformation are ultimately responsible for driving interest in thermal microgrids, which are a decentralized technical pathway for achieving deep decarbonization enabled by advanced digital capabilities.

### 1.3 Goals and Objectives for Local Energy System Development

As referenced above, there are several considerations for local energy system deployment, and stakeholders must first identify and prioritize goals to evaluate a thermal microgrid versus an alternative energy system. The following are the most typically cited categories of goals, many of which are interrelated. Once goals are identified, stakeholders then identify objectives used to achieve each goal, which may be qualitative and/or quantitative. The goals and objectives are prioritized based on the community's shared priorities and values, taking into account the relative trade-offs between each.

- **Economics.** Energy and thermal services costs are a primary concern for all stakeholders. Thermal microgrids leverage economies of scale and enhanced efficiency to reduce costs, as does any district energy approach. The efficiency gains through advanced heat recovery improves the economics further. An economic assessment of a local energy system is typically evaluated using present value costs of the system over the lifetime, which can be compared across a variety of different system designs incorporating both electricity and thermal services.
- **Reliability and resiliency.** Communities that are prone to natural disasters and/or that have customers with critical loads may identify reliability and resiliency as a system design goal. Thermal microgrids incorporate distributed energy and storage and advanced analytics and controls, which enables detection and ride-through of local grid disturbances. Thermal microgrids, like CHP<sup>14</sup>, can be used to enhance reliability and resiliency.
- **Reliance on fossil fuels.** The reliance of an energy system on fossil fuels has price risk implications, in addition to environmental ones. Historically, price shocks of imported fossil fuels have resulted in reduced rate stability. Although domestic production of natural gas through fracking has resulted in low prices for multiple years, the lifetime of an energy system can be up to 40 years. Natural gas prices over this period are uncertain. Price risk volatility can

<sup>12</sup> <https://www.eia.gov/todayinenergy/detail.php?id=25172>

<sup>13</sup> <https://www.eia.gov/electricity/data/eia861/>

<sup>14</sup> [http://www1.eere.energy.gov/manufacturing/distributedenergy/pdfs/chp\\_for\\_reliability\\_guidance.pdf](http://www1.eere.energy.gov/manufacturing/distributedenergy/pdfs/chp_for_reliability_guidance.pdf)

be mitigated by transitioning to advanced waste heat recovery and renewable energy in the thermal microgrid design.

- **Environmental impact.** Minimizing the environmental impact of the energy system is another key goal of cities, campuses, and utilities driven by community preferences for renewables and action on climate change. Thermal microgrids are highly efficient because of their use of advanced waste heat recovery and renewable energy, enabling them to achieve environmental outcomes not possible on a building-level scale at comparable costs or at a district scale utilizing fossil fuel based systems. GHG emissions, local particulate matter and indoor air quality are the most common focus areas, all of which are improved using thermal microgrids.
- **Water usage.** Especially in drought-prone regions, water usage is a key consideration of the energy system design, due to both financial impact and availability of a scarce resource. Leveraging advanced waste heat recovery using heat pumps in the thermal microgrid design reduces water usage, because the waste heat that is recovered would in most cases be discharged using evaporative cooling towers.
- **System flexibility.** Given that energy systems can have a lifetime of up to 40 years, the ability of the energy system to meet future community needs and do so in a way that minimizes the prospect of stranded assets is another key consideration, especially in regions experiencing significant growth. Thermal microgrids can source electricity and heat using several types of technologies, allowing a community flexibility to optimize supply over the long lifetime of the system.
- **Local economic development.** As opposed to utility-scale power generation sited in remote areas of the state used to power building-level equipment, thermal microgrids incorporate central energy facilities (e.g. heat pumps, thermal storage) sited locally, which grant the opportunity for local workforce and business development.
- **Local control.** Another key goal of developing a local energy system is also simply for the community to have local control.

As discussed under each category above, thermal microgrids rank favorable in each category.

## 1.4 Summary of Opportunity

Given the transformation of the energy sector driven by the “three D’s” (section 1.2), now is the time to explore the role of thermal microgrids for achieving clean, affordable and reliable energy systems to serve communities. Public power is uniquely positioned to lead the exploration and development of thermal microgrids, for several reasons. First, municipal electric utilities considering a prospective thermal microgrid are in an informed position to evaluate and act on trade-offs and synergies with other public sector utilities. Municipalities often have several public-owned utilities in addition to electric power, such as wastewater and potable water systems. These additional systems/services can be utilized for heat recovery and exchange in the thermal microgrid, as discussed in greater detail in section 2.2. Similarly, electric and thermal utility services can achieve cost savings through coordinating trenching. A waste heat recovery based system will obviate the need for a local cooling tower, and the associated health risks (e.g. Legionnaires' disease). A municipal electric utility can assess these trade-offs and synergies to maximize the cost-effectiveness across the provision of utility services to the

community. Second, the thermal microgrid, like an electric-only microgrid, is embedded in the larger grid. Public power can standardize interconnection procedures and develop innovative policies and rate structures that harness the value in the flexible and controllable load. Third, the success of local energy system deployment hinges on the ability to navigate complex, multi-stakeholder processes to achieve community goals. Public power agencies have decades - in some cases over a century - of experience serving their communities by leading energy infrastructure deployment, making them ideal entities for steering thermal microgrid development. Fourth, historically, municipal utilities across the U.S. have shown leadership on environmental issues. Direct accountability to the communities they serve enables public power more flexibility in prioritizing non-economic goals of the local energy system (e.g. environmental impact), compared to for-profit utility business models. For all the above reasons, there is arguably no better institution than public power to lead thermal microgrid exploration.

## 2. Technology Description

As described in the prior section, a *thermal microgrid* utilizes a combination of energy efficiency, thermal storage, and renewable energy powered waste heat recovery or other renewable heat supply to provide co-optimized power and thermal services to a group of interconnected and controllable energy loads within a defined boundary. A thermal microgrid therefore includes several categories of technologies, including:

- one or more **heat and cooling sources**, including **thermal storage**;
- one or more **power generation systems**<sup>15</sup>, from clean energy, either located on-site or remotely;
- a **thermal network** of pipelines - including both supply and return – running from the central energy facility to the buildings; and
- **building interconnection equipment** to couple the thermal network to the heating and cooling systems located at the customer site.

Thermal microgrids, like other district energy systems, provide significant flexibility since several technology options are available for most of these functions, and indeed heat and electricity supply sources may be swapped out over time given changes in policies and technology costs and performance. Ultimately, the combination of technologies selected for the final system design depend on the scale of the project, local resource availability, and special performance characteristics, among other factors, and must be analyzed on a case-by-case basis.

The following three sections provide an overview of technology options incorporated into a thermal microgrid, divided into three categories: central equipment, thermal network, and building interconnection equipment. The fourth and final section considers the various energy system architectures (Table 1) and the resultant range of estimated systems efficiency, emissions, and water usage one can expect given available technology choices compared to conventional alternatives.

### 2.1 Central Equipment

#### 2.1.1 Heat Sources

The viability of a district energy system hinges on availability of a low-cost heat source. Heat can be generated or recovered from a variety of sources, either as single output process or in conjunction with power (e.g. CHP). The historical choice for heat production is a thermal power station or a dedicated CHP plant. In the framework of achieving deep decarbonization, however, there are multiple renewable/recovered heat sources that can deliver high-temperature (high grade) heat. Others can provide low-temperature (low grade) heat and then be used in conjunction with heat pumps to achieve a higher output temperature. Table 2 describes a variety of renewable/recovered heat sources that can be leveraged for a thermal microgrid, categorized by high-grade and low-grade heat.

---

<sup>15</sup> Background information on renewable electricity generation systems are not addressed in this report.

Table 2: Possible waste and renewable heat sources, categorized as either high-grade or low-grade heat

High Grade Heat	<ul style="list-style-type: none"> <li>● <b>Waste Heat Recovery from Industrial Processes (200-1,800 °F).</b> Waste heat from industrial processes is commonly available, varying in temperature from extremely hot process industry flue gases down to lower temperature refrigeration exhaust. This heat source is often used in large-scale district energy systems, or for more localized systems when combined with other heat sources.</li> <li>● <b>Deep Geothermal (150-350 °F).</b> Recovering geothermal heat requires deep boring into the ground. Boring costs are substantial and can make this renewable energy source cost-prohibitive depending on specifics of the site. Yet when economically feasible, deep geothermal offers a renewable heat source for base load needs.</li> <li>● <b>Waste Heat Recovery from Municipal Waste Incineration (130-300 °F).</b> The combustion of municipal waste to provide electricity and/or heating (aka <i>waste-to-energy</i>) has been practiced in Europe for many years. Waste incineration occurs continuously throughout the year, making this a base load heat source.</li> <li>● <b>Biomass (130-300 °F).</b> Biomass can be used as fuel for large boilers or for CHP plants, a common choice for district energy systems. Sources of biomass include wood chips, clean construction and demolition lumber, yard waste, tree trimmings and multiple forms of agricultural waste such as oat hulls, etc. Biomass can also be used within existing fossil-fueled boilers as a co-firing to reduce emissions.</li> <li>● <b>Solar Thermal (175-275 °F).</b> Using solar energy as a heat source for district energy systems was traditionally considered infeasible on a year-round basis and utilized only for seasonal heat. Now by integrating thermal storage capacity, solar thermal energy is viable at almost any latitude for many countries. The solar energy can either augment existing heat sources in a thermal network, or feed a stand-alone system incorporating thermal storage to provide thermal heating year-round.</li> </ul>
Low Grade Heat	<ul style="list-style-type: none"> <li>● <b>Waste Heat Recovery from Building Cooling Process (50-80 °F).</b> Stanford’s state-of-the-art system uses the overlap in heating and cooling needs by capturing waste heat from the cooling network return pipe. The overlap in thermal needs leading to opportunity for waste heat recovery has been found to be a robust phenomenon across climate zones and building uses, and should be the first heat recovery source to be pursued given the same heat pump equipment can be used for both heating and cooling needs to capture this opportunity<sup>16</sup>.</li> <li>● <b>Waste Heat Recovery from Municipal Wastewater (50-80 °F).</b> Sewage is a heat source that is available in almost every community. A few degrees of heat can be extracted before or after sewage treatment. In the former case, the heat source is, of course, contaminated. In the latter case, the process is post-sanitation, but source temperature is significantly lower.</li> <li>● <b>Shallow Geothermal (50-80 °F).</b> Shallow geothermal (aka <i>geoexchange</i>) is the recovery of heat from within several yards of the earth’s surface, where the temperature remains relatively constant. Shallow geothermal as a heat source is becoming increasingly common for district energy systems.</li> <li>● <b>Other Waste Heat Recovery Opportunities.</b> There are a variety of other sources of waste heat, a largely untapped potential energy source, including high heat loads from data centers and air- and water-source heat.</li> </ul>

<sup>16</sup> See the SESI case study companion deliverable for more information.

Incorporating multiple heat sources is a standard strategy to improve overall energy system efficiency and increase the penetration of renewable heat sources. Choosing the heat source or sources that are best suited for a local energy system depends upon local resources, climate, system design parameters, source temperature, and customers' thermal needs, among other factors.

### 2.1.2 Cooling Sources

District cooling has potential to help overcome challenges in the cooling sector<sup>17</sup> compared to a building-level cooling approach, while providing multiple additional benefits as described in section 1.3. Conventionally, large commercial customers have electric chillers on-site, which use electricity and a refrigeration cycle to produce cooling. District cooling schemes similarly incorporate chiller equipment in a central plant to produce chilled water. Other cooling source options include the efficient use of renewable electricity in large heat recovery chillers (water-to-water heat pumps), the combination of absorption heat pumps/chillers with a heat source such as those listed in the prior section, or natural cooling (aka *free cooling*) from surface water when considered to not be an environmental concern. Table 3 shows the primary cooling sources used in district energy systems.

Table 3: Cooling sources

- **Heat Recovery Chillers (HRCs) in a Heat Network.** As illustrated by SESI, cooling can be produced from a heat network using large HRCs located at a central plant.
- **Absorption Heat Pumps/Chillers with a Heat Source.** A heat source can be used to produce chilled water using absorption heat pumps/chillers, either located at the building site or at a central plant. Alternatively, a centralized trigeneration system utilizing similar equipment can produce a separate cold supply to serve a district, in addition to power and heat.
- **Surface Water (40-75 °F).** Also known as hydrothermal, lakes, rivers and oceans can be used as cooling source or as a heat sink. Some systems use surface water not just as a cooling source, but in a combined scheme to prepare or provide potable water supply, such as Toronto District Cooling. When the source temperature is not sufficiently low to directly feed the thermal network, a chiller is used to reduce the temperature.

### 2.1.3 Thermal Storage

Thermal storage is a key technology for enabling optimized system operation of a thermal microgrid. Thermal storage systems incorporated into the overall energy system design can increase the amount of heat recovery potential that can be economically exploited, enable electricity load shifting from on-peak to off-peak periods, enhance reliability and resilience by being able to continue to provide service during grid disturbances, and reduce the chiller capacity requirements. To achieve these use cases, the storage system is charged and discharged daily based on results from system-wide optimization. Chilled water is the most common form of cool storage, although ice or ice slurry could also be used. Hot storage is simply hot water, although hot storage is less common in the U.S. compared to Europe.

<sup>17</sup> For instance, in large swaths of the U.S., the system peaks of the electricity grid are driven by AC load, and some building cooling needs are increasing given growth of computer and server use, which are heat generators.

## 2.2 Thermal Network

The *thermal network* is the distribution network of pipes, energy transfer stations, valves and controls to deliver steam, hot water or chilled water from a central energy facility to end customers. Each service in a thermal network consists of a pair of pipes: the *supply* that carries water or steam from the central energy facility to end customers, and the *return* that carries water or steam/condensate back from the end customers to the central energy facility. A district energy approach to serving a community will have an advantage over a building-level approach whenever the cost savings of the energy source and central equipment compared to conventional building-level systems is greater than the capital costs of the distribution network. Therefore, design choices of the thermal network and resultant costs and savings play a significant role in overall district energy system cost-effectiveness. Figure 2 illustrates the three types of thermal networks.

- A **heat network** directly provides the required heat supply to the buildings. A heat network can also provide cooling at the building via on-site absorption chillers.
- A **cooling network** directly supplies the required cooling supply to the buildings. It can also provide heat at the building via on-site heat pumps.
- A **tempered water system**, often referred to as an anergy network in Europe, provides heat or cooling supply directly to the building, whenever the temperature level of the demand is compatible with the network temperature.

The thermal needs of users are primarily domestic hot water and space heating and cooling. In a thermal network, heat transfer is quantified by the flow and temperature difference (*delta T*) between the water in the supply and the return.

Analogous to an electricity grid, a thermal network has a network operator that directly controls the outgoing water temperature and typically opens and closes circulation valves at the delivery points to regulate flow based on building needs throughout the thermal network. The network operator ensures that all customer needs are met, including those at the furthest customers at the end of the network. The return loop temperature is not controlled directly, but is a result of the operating scheme. The return temperature in a heat network is usually kept as low as possible: just high enough to ensure thermal needs of all customers are met, but not higher, so as to maximize overall system efficiency by reducing thermal losses from transportation through the pipes and minimizing pumping energy. Incorporating multiple heat sources can help facilitate operating the thermal network with a low return temperature, to improve efficiency and increase renewable energy penetration. For instance, the renewable heat source could supply 60-80% of peak demand, and comparatively low-cost backup units could be incorporated into the system design to be used as reinforcement during the rarely-occurring peak hours.

Figure 2: Schematic view of three thermal networks: heat, cooling, and tempered water networks<sup>18</sup>

Heat Network



Cooling Network



Tempered Water Network

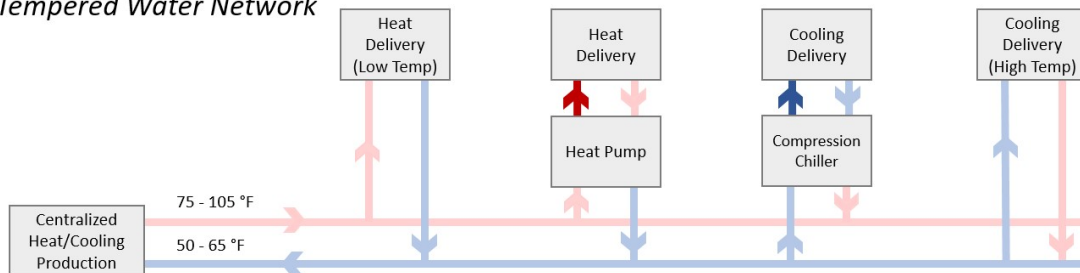

2.2.1 Integrating Heat Supply into the Thermal Network

Most heat sources are only available at limited temperature levels, as indicated in Table 2 (section 2.1.1) and Table 3 (section 2.1.2). The methodology for integrating heat sources into the network supply is determined by the temperature difference between the heat source and the supply and return temperatures of the thermal network. The three cases are as follows.

- When the heat source temperature is higher than the thermal network supply temperature, the heat source can directly feed the thermal network in the supply loop.

<sup>18</sup> Translated and adapted from: Loic Quiquerez, “Décarboner le système énergétique à l'aide des réseaux de chaleur: état des lieux et scénarios prospectifs pour le canton de Genève”, PhD Thesis, 2017.



- When the heat source temperature is in between the supply and return temperatures, the heat source can directly feed the thermal network in the return loop.
- When the heat source temperature is lower than the return temperature of the network, the heat source cannot directly feed the thermal network, and heat pumps are necessary to bring the temperature up to the required level.

### 2.2.2 Thermal Network Piping

There are a variety of materials available for thermal network piping, the selection of which will depend on the energy system architecture (Table 1), thermal network architecture (Figure 2), energy carrier, supply and delivery temperatures, desired flow rate, the local environment, materials costs, installation costs, and anticipated lifetime, among other factors. For hot water distribution systems, the most common piping material is steel with one to several inches of polyurethane insulation and a water vapor jacket applied around the pipe (aka *pre-insulated steel pipes*). For chilled water systems, steel or ductile iron piping has been used historically, although high density polyethylene is increasingly common. When steel pipes are used, they are typically coupled with a leak detection system to enable timely identification of leaks before they result in corrosion and damage. Chilled water piping can be pre-insulated, coated for corrosion protection, or left bare. The up-front and installation costs for pre-insulated piping of a chilled water distribution network are significantly more expensive compared to non-insulated piping. Therefore, a detailed thermal analysis is carried out for a chilled water distribution network to weigh the costs and benefits of insulation for a specific system. The three most important factors that will determine the distribution losses in the thermal network are 1) the thermal conductivity of the piping material, 2) the thermal conductivity of the surrounding soil, and 3) the temperature difference between the fluid and the surrounding soil. Additional factors that impact distribution losses include the pipe diameter, flow velocity, depth of the piping, and distance between buried supply and return piping.

## 2.3 Building Interconnection Equipment

The thermal network can interconnect with customer buildings in two ways.

- **Direct Connection.** The district energy system's supply (i.e. steam, hot water or chilled water) is directly pumped through the customer's building heating and cooling equipment (e.g. radiators).
- **Indirect Connection.** The district energy system is coupled to the building via heat exchangers used to transfer heat between the supply and the customer's building system, keeping the supply isolated from the building heating and cooling system.

The customer building interconnection may be referred to as an *energy transfer station* (ETS). Most district heating systems use indirect connections, while most district cooling systems use direct connection due to the relatively small differential temperatures in chilled water systems. Major determinants of whether to use a direct or indirect connection include the system supply pressure at the building, current building equipment, and building height. Direct connections have the advantage of requiring less space, lower maintenance costs, and lowest return temperatures, maximizing the "delta T" between the supply and return leading to overall higher system efficiency and cost-effectiveness. However, they require increased power consumption to maintain sufficient pressure at the building interconnection points, make leak detection more challenging, and reduce reliability overall. When the pressure difference does not allow a direct connection, an indirect connection is

used. Indirect connections are advantageous in that they provide compatibility for building interconnections with any district energy system pressure and temperature.

Controls are installed at the interconnection points to limit the maximum flow rate and keep the thermal network in balance. In addition to controls, heat meters and isolation valves and filters are also installed for billing and equipment protection, respectively.

## 2.4 Building Heating and Cooling Equipment

Although technically outside of the purview of the district energy system owner and operator, customers' building heating and cooling equipment must be compatible to interconnect and receive thermal services. The building system should be sized to meet peak demand, and no more: an oversized building heating system results in oversizing the entire thermal network to meet customers' needs. Of particular importance is the operating temperature of the building's heating systems: the building supply temperature must be lower than the thermal network supply temperature, and the building's supply and return temperature should be adjusted to reduce the return temperature as much as possible. The more critical design criterion is the building return water temperature – this should be driven as low as possible for maximum system efficiency.

## 2.5 Energy System Performance

A generalized comparison of energy system performance evaluated based on energy efficiency, emissions, and water usage can be challenging, given that a variety of local conditions will ultimately impact the actual system viability. Nonetheless, here we provide a simplified, high-level evaluation of performance of two energy system architectures, SHP and CHC<sup>19</sup>. To carry out the comparison, we assume a common fuel (natural gas) and make the following assumptions.

- Electricity consumption from the grid is provided by a new natural gas fired combined cycle power plant with a 52% efficiency<sup>20</sup>.
- District heating is from new natural gas fired equipment with an 85% efficiency on a higher heating value (HHV) basis.
- District cooling from new chiller and cooling towers has an efficiency of 0.5KW/ton.
- Heat recovery chillers have an efficiency of 1.5KW/ton.

We compare SHP to a CHC system powered from grid electricity, by evaluating how much natural gas is required to provide one ton of chilling and 17,100 BTU of heating. Given the above assumptions, the total required using SHP is 23,339 BTU. This is compared to the total from CHC is 9,845 BTU. Therefore, CHC would use 57% less natural gas than SHP, and consequently result in a commensurate amount of GHG reductions. Limiting the use of evaporative cooling towers to reject waste heat further reduces water usage in the CHC design, of particular significance in drought-prone regions of the country.

---

<sup>19</sup> This section is paraphrased from the SESI case study companion deliverable, included here for completeness.

<sup>20</sup> *Thermal Efficiency of Gas-Fired Generation in California: 2015 Update*, California Energy Commission.

## 3. Overview of Project Economics

The deployment of a thermal microgrid is a major infrastructure project that incorporates substantial fixed project costs, along with ongoing electricity/fuel and operations and maintenance costs. However, in addition to the system design maximizing efficiency resulting in cost-effectiveness, the project may also lead to additional significant offsets: costs that would need to be incurred if maintaining the existing energy system, such as expensive electric distribution system upgrades. The subsections below outline and describe the typical project cost categories for thermal microgrids.

### 3.1 Primary Fixed Costs

Fixed costs for a thermal microgrid - or many district energy system configurations - can easily run in the hundreds of millions of dollars, potentially making up half of the total system costs over the anticipated lifetime, with the balance being made up by operations and maintenance (O&M), electricity, and fuel. The primary categories of infrastructure costs for thermal microgrids are as follows<sup>21</sup>.

#### 3.1.1 Central Equipment Costs

Thermal microgrids have central equipment that includes, for instance, heat sources, heat pumps, chillers and thermal storage. Depending on the energy sources used, the specific fixed costs in production capacity and unit variable costs related to the production of a unit heat and be very different from one system to another. Centralized renewable electricity generation equipment located on-site, such as distributed solar PV, may also be incorporated into the system design.

#### 3.1.2 Thermal Network and Building Interconnection Costs

Distribution occurs via the thermal network, which consists of underground pipes, energy transfer stations, pumps and controls carrying steam or hot/chilled water, as described in section 2.2. With regard to costs, the key parameter is linear thermal density, or the amount of heat/cooling distributed annually per linear foot of the thermal network. Unit thermal network costs are inversely proportional to linear thermal density. Explained another way, the largely fixed costs of the distribution network and customer connections can be shared across more units of thermal service when the customer load is denser, resulting in a more cost-effective system. Building interconnection costs can be many multiples of the thermal network itself and vary depending on building type and corresponding thermal load.

It is worth noting that even if the per unit costs of delivering thermal services is higher in low-density areas, district energy can still be cost-competitive, especially if/when the heat sources are cheap and distribution losses are minimized. Furthermore, on the other extreme, high-density urban centers can present their own set of challenges, since thermal network installation can be complicated and expensive in crowded underground space.

---

<sup>21</sup> Cost estimates based on the European market can be found in United Nations Environment Program's 2015 report, "District Energy in Cities - Unlocking the Potential of Energy Efficiency and Renewable Energy".

## 3.2 Primary Ongoing Costs

The two largest sources of ongoing costs are O&M and electricity/fuel, which are approximately proportional to units of energy sold<sup>22</sup>. O&M costs consist of maintaining the central energy facility equipment, in addition to any building interconnection equipment. The thermal network itself requires little maintenance and has an expected lifetime much longer than the central equipment. Supply equipment can be switched out one or more times while maintaining the same distribution network. O&M can comprise up to a fifth of the total costs over the system lifetime, depending on the energy system architecture and other system design choices.

Electricity and fuel are the other main source of ongoing costs. Depending on the energy system architecture, supply sources, and climate, among other factors, electricity and fuel of a new energy system can make up half of the total lifetime system costs. Thermal microgrids are designed around renewable electricity powered heat recovery; therefore, electricity costs can be substantial and fossil fuel sources are minimized, used only for capacity serving peaking and backup needs.

## 3.3 Other Costs

Although Section 3.1 and 3.2 cover the primary up-front and ongoing costs for a thermal microgrid, there are many other costs that are material, including the following.

- **Project development costs.** Often starting multiple years prior to breaking ground, feasibility studies, detailed engineering designs, and permitting and planning applications require substantial resources to carry out.
- **Customer acquisition.** For a new local energy system development, it can take significant time and resources to acquire a set of core customers to form the anchor loads for the system. To encourage building owners to subscribe for thermal services, some district energy developments under-recover fixed costs in the early years of the system lifetime.
- **Metering, billing, customer service and administration.** Like any utility service, a district energy system operator must meter, bill, respond to customers, and operate in accordance with municipal, state and federal laws and regulations. A portion of these costs - specifically billing, customer service and administration costs - may be shared across multiple utility services. Heat metering equipment costs are often already accounted for under building interconnection costs.

## 3.4 Synergies with Other Utility Services & Customer Needs

As discussed in section 1.4, public power is in a unique position to lead in the development of district energy systems because of their ability to identify and capitalize on cost savings across multiple utility services. Coordinating infrastructure projects for the thermal network and electricity grid is one major example of this. As described above, thermal networks are underground networks. Trenching and pipe installation for the thermal network could be coordinated and combined with installing (new development) or undergrounding (existing development) the electricity distribution system. Power lines and supply and return piping can be arranged in such a way to mitigate any potential negative impacts of elevated temperatures on the power lines. Insulating foam boards can also be added

---

<sup>22</sup> O&M is also often expressed in terms of percent capital costs.

around the power lines if they must be within close proximity to the thermal network. Combining the installation of piping and installing/undergrounding power lines can result in substantial savings for communities. These potential savings should be taken into account in the evaluation of cost-effectiveness of the various local energy system options. Similarly, deploying a thermal microgrid can help delay or avoid major infrastructure investments in the electric distribution system for neighborhoods undergoing new development or major redevelopment accompanied by a substantial increase in electricity demand.

In addition to coordinating costs across utility services, there are also customer considerations that can be factored into whether a district energy system architecture is preferable over a building-level system. Having a district energy system reduces on-site capital expenditures required of customers. For Austin Energy, for instance, the primary motivation for exploring a central cooling plant was to reduce development costs for new buildings in a brownfield redevelopment area. The district cooling system precluded the need for chiller equipment installed in the new buildings, an offset to customer-financed capital projects. Although these costs would have been incurred by the customer, as opposed to the utility, customer preferences nonetheless play a significant role in determining the preferred local energy system design.

### 3.5 Comparison of Project Economics Across System Design

Prior to deciding on a specific system design, one must compare the project economics to alternatives, such as CCHP, CHP, SHP, and a building-level system. Furthermore, there also may be several different design variations within each of the aforementioned categories. A *business as usual* (BAU) system design is defined as a continuation of the existing energy system and used as a baseline for comparison. Section 4 (next section) describes techno-economic feasibility assessments, which aid in arriving at the subset of system design options that are sufficiently promising for more detailed evaluation.

As with any major infrastructure project, a variety of methodologies can be used to carry out the economic assessment. The methodology used in this report is to calculate the present value of projected cash flows. Standard project finance inputs such as discount rate, project lifetime, cost input estimates, cost of debt, etc. are all incorporated into the assessment. Sensitivity analyses can be used to determine to what extent the results change given changes in input assumptions. When assessing project economics, it is also critical to accurately capture all costs and benefits of each system including potential offsets, such as those described in section 3.4.

For illustration, Figure 3 summarizes the results of the economic assessment of multiple central energy replacement options, duplicated here from the SESI Case Study. Along the horizontal axis are all system design options considered, categorized by power source (on-site gas cogeneration, grid power, grid power plus solar), heat network (steam or hot water), and level of heat recovery (none, modest heat recovery, and major heat recovery). On the left vertical axis is present value costs in millions over the anticipated 35-year system lifetime (2015-2050). Costs are broken down by four sources: electricity, natural gas, O&M, and capital. Water usage and GHG emissions are plotted along the right vertical axis to reflect the environmental impact of each system design option. Figure 3 is specific to Stanford's detailed evaluation of replacement options for their 1987 cogeneration plant (BAU). However, the relative trends between energy system design options are transferable to other locations.

# APPENDIX E



Thermal Microgrids: The Technology, Economics and Opportunity

Figure 3: Stanford's central energy facility replacement options

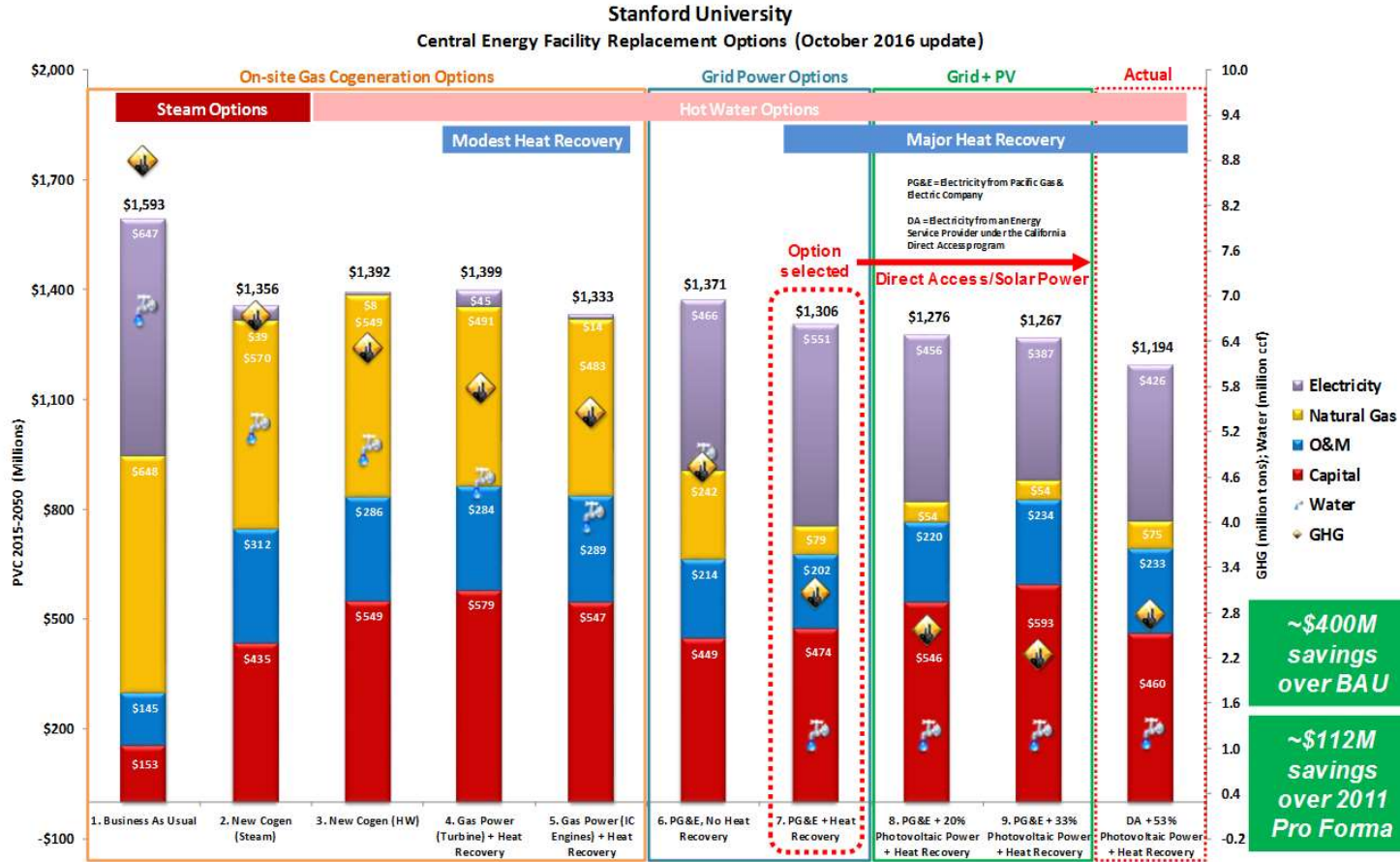

## 4. Feasibility Assessment

The progression of district energy system design can be categorized into four stages, as shown in Table 4. As a project advances through each stage, the number of system design options under consideration narrows, estimates of project costs are refined, and project risk declines.

Table 4: Stages of a district energy project

1. Pre-Feasibility	<ul style="list-style-type: none"> <li>This is the initial stage of assessment when all system design options are under consideration. Pre-feasibility assessments are typically carried out several years in advance of the beginning of project construction and require minimal input. Tools for pre-feasibility assessments may be referred to as <i>screening tools</i>.</li> </ul>
2. Feasibility	<ul style="list-style-type: none"> <li>The second stage is the feasibility assessment. The category of models to determine whether a given system design is technically and economically feasible subject to the operational constraints of component technologies and other physical limitations of the system operation fall within the general category of <i>techno-economic feasibility models</i>. More detailed input data is required at this stage in the assessment, such as hourly heating and cooling loads and long-term forecasts for electricity and fuel prices. The outcome of a feasibility assessment may be expressed in a chart such as that shown in Figure 3. At the end of this stage, stakeholders decide on the final energy system architecture and have estimates for equipment sizing.</li> </ul>
3. Engineering Design	<ul style="list-style-type: none"> <li>The next stage is detailed engineering design of the identified system architecture, and refined costing.</li> </ul>
4. Request for Bids	<ul style="list-style-type: none"> <li>The final step of the project is issuing a request for bids. At this stage, all aspects of system design are finalized.</li> </ul>

This white paper focuses on models and methodologies that fall within the first two stages: pre-feasibility and feasibility. Given promising results from results of these two stages, additional time and resources can be devoted to carry out a more detailed technical and financial assessments. Please note that a companion deliverable of this four-part APPA-funded project catalogues and describes pre-feasibility and feasibility tools for thermal microgrids. Discussion of specific tools and their capabilities is reserved for that deliverable, scheduled to be released in Summer 2018.

Prior to beginning any modeling work, stakeholders should determine a prioritized list of goals, such that a subset of system design concepts can be evaluated via a pre-feasibility assessment. As discussed in section 1.3, a community may have a variety of goals for its local energy system. One goal could be, for instance, reducing GHG emissions by 40% by 2030, which a thermal microgrid would be instrumental in helping to achieve. Stanford's goals were to minimize GHGs and energy and water usage within reasonable cost, for instance.

Also prior to the pre-feasibility assessment, the boundary must be defined within which the local energy system will serve customers. Multiple geographic boundaries could be evaluated, adjusted iteratively throughout the design phase. For the case of Stanford, the geographic region of interest included the university campus.

### 4.1 Pre-Feasibility Assessment for Thermal Microgrid Design

A common component to any feasibility assessment is collecting the heating and cooling loads of all buildings within the district, or, if historical data is unavailable, modeling the loads using building energy modeling tools. Calculating hourly heating and cooling loads is needed to determine the overlap in heating and cooling needs and the resultant waste heat recovery potential. Significant waste heat recovery potential warrant further investigation into the feasibility of a thermal microgrid.

Figure 4 shows the historical hourly heating and cooling loads for Stanford campus over a calendar year. This figure accounts for hot and cold storage in the calculation of heat recovery potential. In addition to Stanford, substantial opportunity for waste heat recovery is observed in other regions, as shown in Figure 5. As shown on each figure, even in significantly different climate zones and on non-research university campuses, the potential for waste heat recovery is substantial. Stanford’s administrative campus is currently under construction and utilizes a SESI system design<sup>23</sup>.

Figure 4: Stanford’s campus-wide hourly heating and cooling needs over a year, indicating heat recovery potential for a system incorporating hot and cold thermal storage

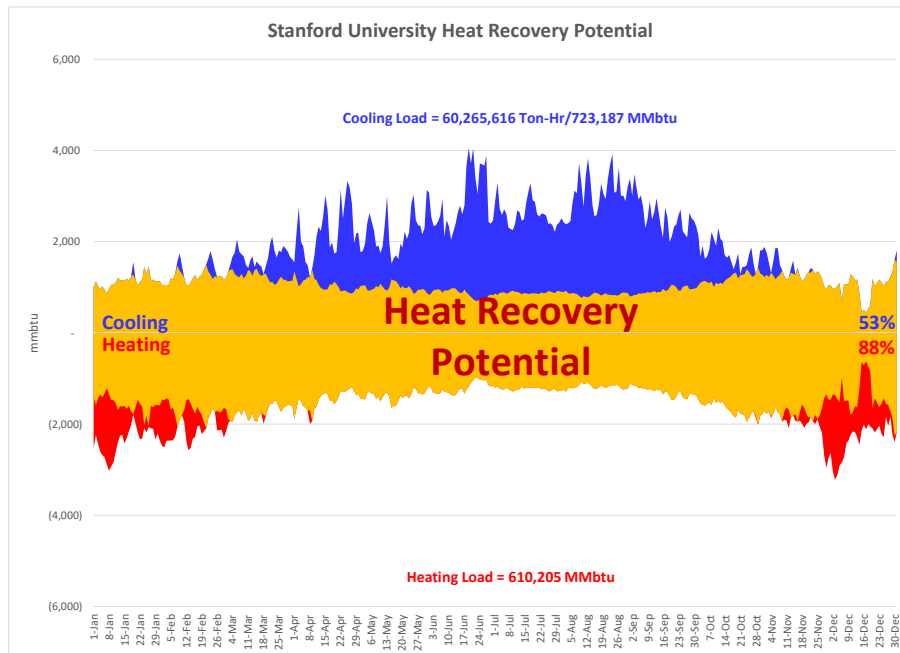

<sup>23</sup> <https://redwoodcity.stanford.edu/>



Figure 5: District hourly heating and cooling needs over a year for Stanford's Redwood City administrative campus (top), University of Illinois Urbana Champaign (middle), and University of California Davis.

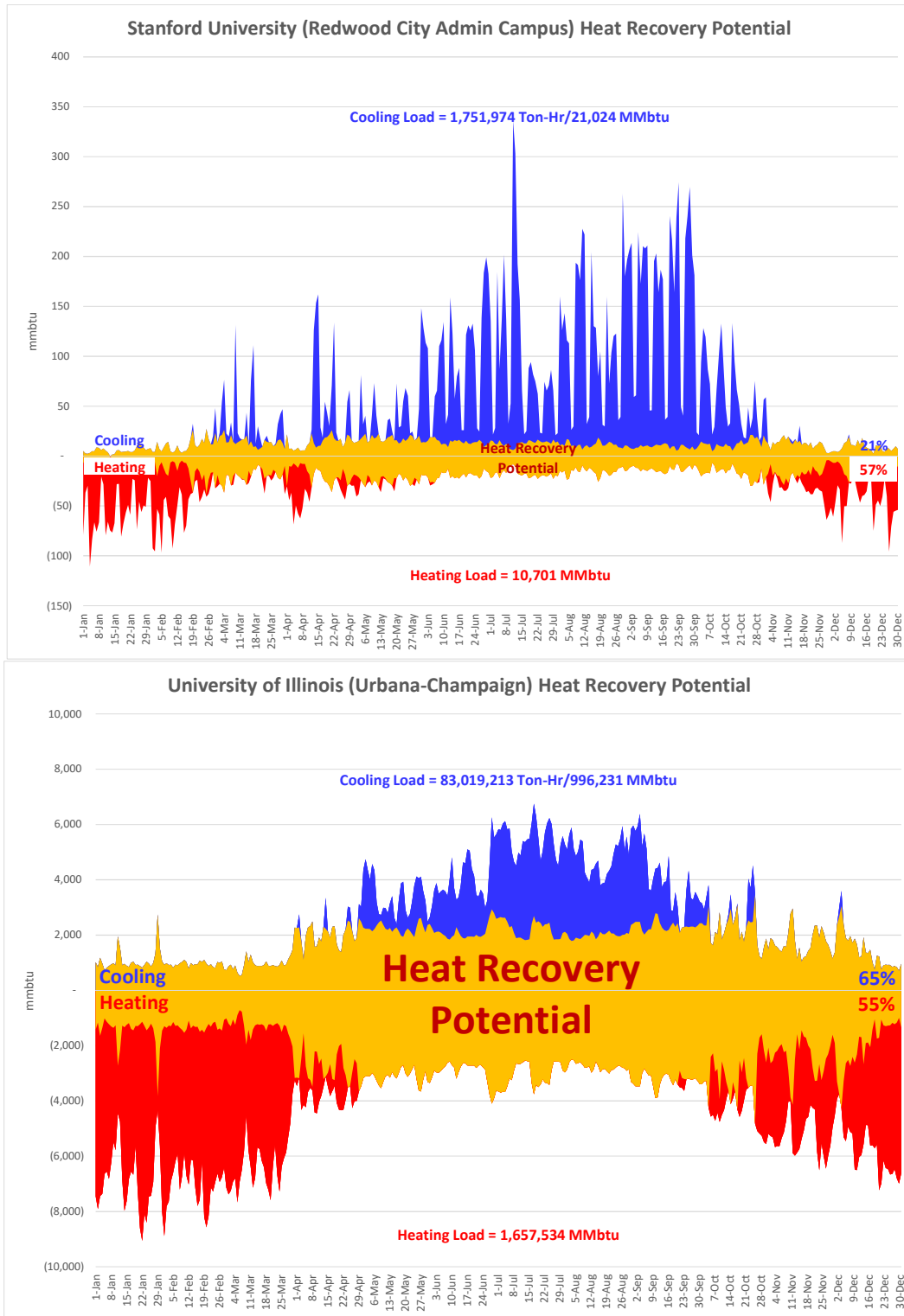

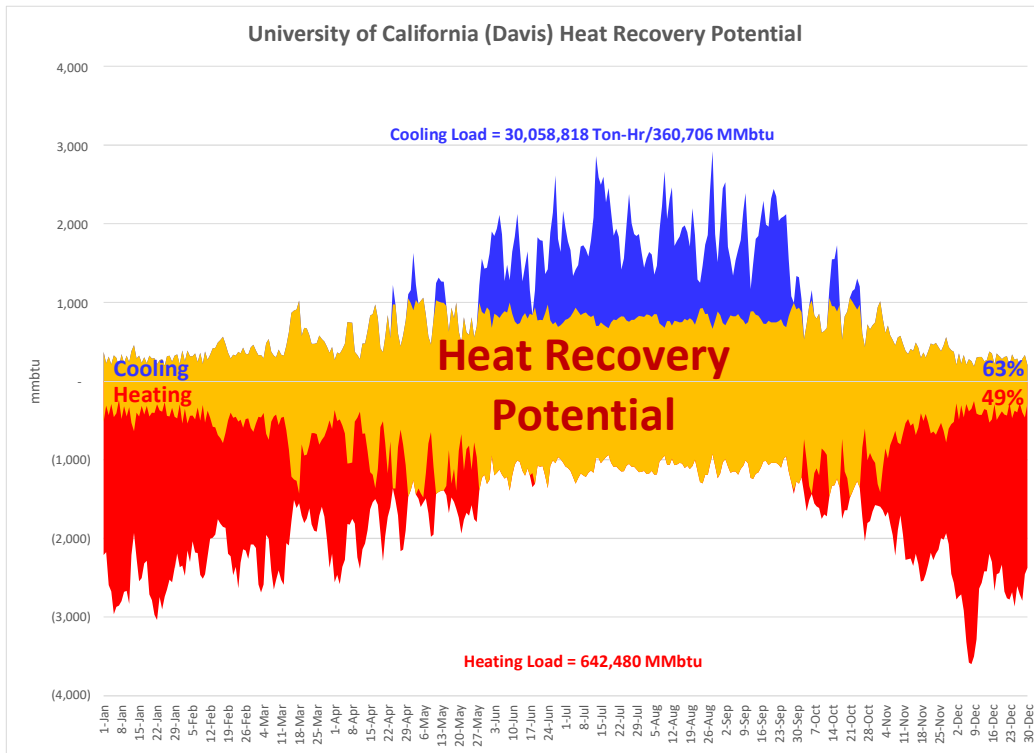

When building waste heat recovery potential is minimal given low coincident cooling needs, the system design can incorporate supplemental heat sources, such as renewable heat recovery from the ground, surface water, or air, or other described above (Table 2). In addition to thermal microgrid system design options, building-level design options and traditional district energy system architecture (i.e. CHP) could also be evaluated simultaneously for comparison purposes.

Note that these diagrams depict the maximum overlap of heating and cooling that could be considered. Conditions such as density of load, difficulty of thermal grid installation and other constraints may limit the number of buildings can be economically connected to the thermal grid.

## 4.2 Methodology for Techno-Economic Feasibility Assessment

Upon narrowing the system options after the pre-feasibility assessment, the next stage is determining project feasibility. The basic methodology is as follows. Examples from Stanford’s energy system transformation are included for illustrative purposes. Note that some of the data will already have been collected for the pre-feasibility assessment.

1. **Gather input data.** There are three main categories of input data.
  - a. *Heating and cooling load profiles.* The energy system must be designed to meet the heating and cooling needs of the region over the system lifetime. As such, heating and cooling load profiles are a key input to the model. Building loads vary depending on the specific building use (hospital, office building, etc.), time-of-day, season, and building age, among other factors. The higher the load data resolution (temporal and spatial), the more confidence one can have in the results of the feasibility assessment,

but the more onerous the study. Two features of the load profile are the base load (minimum level of demand) and the peak load (maximum demand), which are often expressed on an hourly basis and are critical for determining appropriate system design and sizing. If historical load data is unavailable, one can estimate the heating and cooling load profiles using building simulation models or by making rough assumptions based on square footage, climate zone, building use, etc. Irrespective of whether historical data is available, one must consider anticipated *future* energy consumption and development over the project lifetime, which can be decades. Figure 4 (above) shows Stanford's hourly heating and cooling over a calendar year, in addition to the heat recovery potential.

- b. *Electricity, fuel and emissions price forecasts.* Forecasts for electricity, fuel and emission prices are key inputs to the model, especially to compare to baseline system designs. Often multiple forecasts are used to identify a range of potential outcomes.
  - c. *Technology characteristics.* If it is not already integrated into the model, information about component technologies incorporated into the system design must be provided as inputs, such as lifetime, rated capacity, operational constraints, capital cost, fixed and variable operations and maintenance costs, efficiency and emissions rate. Technology information may be included in libraries already integrated with the modeling tool.
  - d. *Other.* In addition to the primary data categories, the user may provide other inputs such as discount rate, financing costs, and any specific stakeholder objectives identified (e.g. a GHG emissions cap).
2. **Run techno-economic feasibility model.** Using the input data gathered in the prior step, run the model for all system designs of interest. Output of a model run may include present value cost (PVC), GHG emissions, and water usage. Financial output could be framed in terms of cost-effectiveness from a customer, utility, and/or societal perspective. Results from Stanford's are shown in Figure 3 (above).
  3. **Iterate through steps 1-4, modifying design choices, input assumptions, and objectives.** Depending on the outcome of the model runs, one may wish to evaluate modifications to the initial geographic region, system designs and other input assumptions. In this respect, the techno-economic feasibility assessment is an iterative process that may lead to alternative design options that were not originally considered.

### 4.3 Key Feasibility Drivers

The primary feasibility drivers of a thermal microgrid compared to a building-level system design are the following.

- **Load density.** The primary feasibility driver of a district energy system is the density of heating and cooling needs within the geographic region of interest. Heating and cooling networks are more localized than electric networks. Furthermore, the thermal network is a major source of project costs: the closer the buildings and the denser the load, the more cost-efficient the thermal network will be. The International Energy Agency (IEA) estimates that a region can be

served economically with district energy if the heating load density is at least 0.93 kWh per square foot or the linear heat demand is at least 9,146 kWh per foot<sup>24</sup>.

- **Cost of heating and cooling supply.** The cost of source heat is another primary feasibility driver. Advanced heat recovery enables low cost source heat for a thermal microgrid design. In addition to waste heat recovery from the building cooling process as in the Stanford energy system design, other renewable and waste heat recovery opportunities include data centers, industry, and air-, water- or ground-source heat, for instance.
- **Load diversity.** Sizing each individual building for its annual peak demand is inherently more expensive than sizing a collection of buildings with load diversity. Especially with increasingly ambitious energy efficiency targets for buildings, the problem of sizing will become increasingly challenging. Advanced communications and controls to operate the resources and loads of the thermal microgrid can capitalize on load diversity and further enhance efficiency gains. Even though university campuses can capitalize on their high load diversity given different building uses, even aggregating loads of the same use (e.g. single family residential) can provide benefits. Load diversity, nonetheless, can be considered a key feasibility driver.
- **Implementation Difficulty.** The ease and relative cost of the implementation of the thermal network to connect the buildings is another key consideration and feasibility driver.

---

<sup>24</sup> District Heating and Cooling, Frederiksen and Werner (2013).

## 5. Assessment of Potential in the U.S.

Although a comprehensive quantitative study of the potential of thermal microgrids in the U.S. is beyond the scope of this white paper, we can provide insight on the potential based on existing literature, and technology and policy trends. Many types of state and federal energy and environmental regulations would serve to promote thermal microgrids and their energy efficient, cost-effective approach to decarbonization, including a carbon tax, a cap-and-trade program, energy efficiency targets, and local air quality standards. As referenced in prior sections, there are several non-technical barriers that could significantly inhibit thermal microgrid deployment, such as the following.

- **General familiarity with district energy and advanced waste heat recovery** in the U.S. is lower relative to Europe and Asia, given the lower incidence rate of projects. Additional effort is required for stakeholder education – especially policy makers and the public – to ensure thermal microgrids are considered alongside other options for decarbonization.
- **Parts of the value chain for district energy are under-developed in the U.S.**, resulting in too few vendors to create a competitive market. Furthermore, thermal microgrid systems such as Stanford’s are an emerging system design on the global stage, meaning expertise with this system type is even more scarce. Government policies to support upstream development of the value chain could help spur efficient market development.
- **Complex, multi-stakeholder processes** for energy infrastructure development can be a major inhibitor to district energy deployment. Active engagement of stakeholders and consideration and responsiveness to concerns will aid in navigating the project development process.
- **Securing the large initial investment** required for capital outlay is another challenge. Sticking points for potential investors include depreciation duration, access to finance, and potential financial risk given uncertainties in the final rates, actual building load, and energy market evolution (policy and regulations), for instance.
- **Timing of building equipment replacement** in existing developments, unless advanced building retrofits are considered, is a critical practical factor in district energy deployment and of primary importance to potential customers. The development of the thermal network could potentially be timed, such that it is developed in phases, matching natural replacement times of buildings.
- **Space constraints** for siting and hosting central energy equipment for district energy can also be a challenge in some areas. Regions with sufficient thermal density are more likely to encounter space constraints.
- **Customer acquisition** can be another challenge, given factors such as negative perceptions about reliance on long-term contracts for heat supply. Although on the customer side, these downsides are counterbalanced by consumer convenience of not having responsibility for boilers and fuel purchases.
- **Project replicability** is another barrier. Unlike with CHP, where there are now several packaged system options available in a variety of system sizes, thermal microgrids have not reached that

state of maturity. Standardization would allow for streamlined installation and maintenance and lower overall project risk.

- **Economic and policy uncertainties over the long project lifetime** are also a barrier. The world is rapidly changing, making long-term investment decisions, such as energy infrastructure development, more challenging.

As mentioned above, carrying out a comprehensive potential assessment for thermal microgrids across the U.S. is a complex undertaking beyond the scope of this white paper. However, it is the subject of ongoing R&D activity. Please see Appendix B for general background on energy technology potential assessments and application to thermal microgrids.

## 6. Utility Business Models for Thermal Services

District energy systems, like electricity and gas networks, are natural monopolies. There are multiple design choices for utility business model for thermal services, which are largely similar to the options available for municipal electric utilities. The subsections below identify and describe some of the primary business model design considerations.

### 6.1 Ownership & Governance Structure

There are multiple ownership and governance structures for municipal utilities that can be utilized for thermal services, just as they are used for electric utilities. Each structure has strengths and weaknesses, and the best ownership and governance structure for a specific system will depend on the community's desired amount of control, investment, and risk, as well as the overarching local energy system goals and objectives. Whatever business model is chosen, it should ensure that all stakeholders achieve financial benefits from the development of a district energy system, including the investors, owners, operators, end customers and municipalities.

Four common business models for district energy systems are as follows.

- **Enterprise fund and operational department within a university or local government.** Municipal utilities that exist within a municipal government or university typically establish themselves as an enterprise fund and an operational department within the organization. The City of Palo Alto's Utilities Department and Stanford's SESI are both established in this way. The governance structure of the department is the same as the larger organization. For instance, a city council will act as the governing body for the municipal utility. Utility directors are granted authority by the governing body to make procurement decisions within approved limits. Procurement exceeding this authority or decisions with important policy implications may require the full review and approval of the governing body.
- **Special district independent from existing local governments.** The second option is to establish a special district - typically referred to as a municipal utility district in this context - that is organizationally independent from established municipal and county governments and is governed by its own set of elected or nominated board members. The sole purposes of the district would be to develop, own and operate the utility, and the governing board is defined upon creation, contingent upon constraints in the enabling state legislation.
- **Community-owned non-profit cooperative.** Third, a municipality can form a private, wholly community-owned non-profit cooperative, where customers (owners) have indirect representation for selecting the board. This model is common in Europe.
- **Community-owned limited liability corporation.** The fourth option is to form a private, wholly-owned subsidiary, with a board comprised of representatives of local building owners, local electric utilities and municipalities. This is typically achieved using a special purpose vehicle (SPV). Although structured as a for-profit entity, municipalities often own stakes in the company. District Energy St. Paul has this ownership and governance approach. In Germany,

utility services are commonly provided by *stadtwerke*, which typically are structured as a limited liability, for-profit entity majority-owned and therefore controlled by a municipality<sup>25</sup>.

There are also a variety of other public-private partnership structures that could be used, such as joint ventures and concession models<sup>26</sup>. Moreover, a completely privately owned, for-profit corporation could develop, own and operate a thermal microgrid. However, the downside of this model is that a for-profit entity has a higher cost of capital and they do not incorporate community-driven governance approaches that may be needed to make the project a success. Furthermore, such a project must comply with zoning, environmental, health and safety requirements. Navigating compliance with such laws and regulations requires cooperation with local agencies. Therefore, most successful district energy business models incorporate the public sector in some way.

Advisory commissions comprised of industry experts from within the community may be established and leveraged to provide an additional layer of review and stakeholder feedback that could be incorporated into any of the organizational structures described above.

## 6.2 Metering & Rate Structures

Thermal microgrid systems that serve multiple customers must incorporate metering equipment to measure customer-level energy usage, so that accurate billing can be carried out for all entities within the service territory. For systems that cover a region with existing electric utility accounts, the existing electrical metering equipment should be sufficient for accurate billing for electric service. However, submetering equipment at the building level may be desired. State or local regulations may dictate what rates may be charged in the submetering context. For instance, in California, the same rate as the local utility must be used for electricity charged to tenants.

The thermal services provided by the local energy system will require separate, dedicated metering infrastructure. Furthermore, the metering equipment and approach will be dependent upon the medium of delivery: water vs. steam. For water-based systems, the focus of this report, a simple approach is to install a single meter at the building for each network for measuring supply and return water temperature. The temperature differential can then be used to determine the amount of heat delivered to the building, which is used to charge the customer. This same approach can be applied for both the chilling and the heating loops. Of course, this is only one approach for metering thermal services. An alternative is charging based on square footage or an engineering estimate of energy needs. Ultimately, the community and the governing board must decide on appropriate cost-recovery mechanisms for their energy system, compliant with local, state and federal regulations.

For heating, cooling, and hot water consumption, charging based on square footage or estimation of usage, based on common engineering standards, may be the easiest and most straight forward option. The electrical equivalent to this is “master metering”, where the public utilities commission designates baseline quantities of electricity for the average residential customer’s reasonable energy needs<sup>27</sup>. This

<sup>25</sup> See for instance Munich’s *stadtwerke*, Stadtwerke München GmbH: [swm.de](http://swm.de) (English option)

<sup>26</sup> For more case studies of district energy systems with various ownership and governance structures, please see the IEA Technology Collaboration Programme on District Heating and Cooling including Combined Heat and Power, Governance Models and Strategic Decision-Making Processes for Deploying Thermal Grids.

<sup>27</sup> Please note that this approach is only appropriate when the functional use and occupancy time of all spaces is similar. If vast differences exist, various factors must be applied to higher load spaces to account for greater heating and cooling consumption.



same type of metric may need to be developed for district-scale heating and cooling. Metering the water flow is another option, though this can be costly and problematic.

## 7. Conclusions, Outlook & Next Steps

The “three D’s” -- decentralization, decarbonization and digitalization -- are driving the transformation of the energy sector, and concurrently encouraging consideration of efficient district electrification as a technology pathway for achieving clean, affordable and reliable energy systems to serve communities. There are several non-technical challenges to market uptake, as described in this report. Nonetheless, they are not insurmountable, and public power in particular is in a unique position to overcome them.

Further evaluation of the market potential and the transferability of thermal microgrids across climate zones and community circumstances is needed, while comprehensive evaluation of technology pathways for decarbonization and resultant policy formulation at the state and local levels are both still in formative stages. This white paper is the deliverable for Part 1 of a four-part APPA-funded project, *Leveraging Experience from Stanford and EDF to Develop Information and Tools for Thermal Microgrid Feasibility Assessments*. The following companion deliverables are either completed or in development, with anticipated publication dates included in parentheses.

- Part 2: Case study describing the Stanford Energy System Innovations (SESI) project, in which their campus-wide cogen system was transformed into to renewable electricity powered heat recovery with low temperature hot water distribution. (Early 2018)
- Part 3: A compilation of tools for assessing technical and economic feasibility of thermal microgrids. (Summer 2018)
- Part 4: Case studies applying the tools to carry out techno-economic feasibility assessments of regions within municipal utility service territories. (Fall 2018)

Please see Appendix A for additional further reading.

## Appendix A. Further Reading

The following on-line references provide additional information on district energy project development and its role in achieving deep decarbonization.

- [\*Community Energy: Planning, Development and Delivery\*](#), IEA (2010). This free guide was developed to help land use planners and prospective project developers "understand and create or influence energy maps [...] and other information for use in master plans or development plans; gain an understanding of energy use in buildings and developments; recognize where there are opportunities for district energy projects, and understand the value of incorporating thermal energy considerations in planning efforts; translate energy opportunities into financially viable and deliverable, sustainable projects; [and] understand the stages of developing an energy project and who is involved in each."
- [\*District Energy in Cities: Unlocking the Potential of Energy Efficiency and Renewable Energy\*](#). UNEP (2015). This report: "identifies modern district energy as the most effective approach for many cities to transition to sustainable heating and cooling, by improving energy efficiency and enabling higher shares of renewables. Countries such as Denmark have made modern district energy the cornerstone of their energy policy to reach their goal of 100 percent renewable energy, and, similarly, other countries, such as China, are exploring synergies between high levels of wind production and district heating."

Locally appropriate policies are required to harness the multiple benefits of district energy systems, lower upfront costs and reduce financial risk for investors. This publication is one of the first reports to provide concrete policy, finance and technology best-practice recommendations on addressing the heating and cooling sectors in cities through energy efficiency improvements and the integration of renewables, both of which are central to the energy transition. These recommendations have been developed in collaboration with 45 champion cities, all of which use district energy, with 11 of them using it to achieve 100 per cent renewables or carbon-neutral targets."

The following recent textbooks can provide more detailed technical information for interested readers.

- [\*District Heating and Cooling\*](#), Svend Frederiksen and Sven Werner (2013).
- [\*Advanced District Heating and Cooling \(DHC\) Systems\*](#), Edited by R. Wiltshire (2016).

## Appendix B. Energy Technology Potential Assessment

### B.1 Introduction to Technology Potential Assessments

Energy technology potential assessments are customarily divided into four stages<sup>28</sup>. First, *resource potential* is the energy content of the resource after accounting for any theoretical physical potential and constraints. Second, *technical potential* is the market size of a technology after considering resource potential and all technical limitations and constraints, such as technology efficiencies, land-use constraints, or topological constraints to arrive. Third, *economic potential* takes the technical potential and accounts for projected costs and benefits such as technology and fuel costs to arrive at the level of technology deployment that is economically viable (i.e. cost-effective). Fourth, the *market potential* is an estimate of the ultimate, realistically achievable market size, using the technical potential and accounting for all remaining factors affecting deployment, such as policies and regulations, consumer behavior, and competing products. At each stage of the assessment from resource potential to market potential, the estimated market size decreases, often considerably. The potential for an energy generation technology is calculated in terms of megawatts capacity, or megawatts capacity thermal equivalent for a district energy system such as a thermal microgrid. Table 5 illustrates the stages of a potential assessment using rooftop solar PV as an example.

Table 5: Illustration of energy technology potential assessment for rooftop solar PV in the U.S.

Resource Potential	<ul style="list-style-type: none"> <li>Resource potential is the average annual solar energy reaching building rooftops in the U.S. This value could be estimated, for instance, using location-based solar irradiance data from the National Oceanic and Atmospheric Association (NOAA) meteorological stations and satellite imagery analysis for building roof footprints.</li> </ul>
Technical Potential	<ul style="list-style-type: none"> <li>Technical potential is the average annual solar electricity that could be generated if solar PV was installed on all suitable rooftops, which can be estimated, for instance, using geographic information systems (GIS) analysis to calculate the solar suitable area of rooftops after eliminating surfaces that are too steeply sloped, poorly oriented, shaded, cluttered with rooftop equipment, or otherwise unable to accommodate solar panels. The calculation accounts for solar PV panel and inverter efficiencies to estimate output.</li> </ul>
Economic Potential	<ul style="list-style-type: none"> <li>Economic potential is the fraction of technical potential that is cost-effective, which occurs when the total value created from system (i.e. bill savings) exceeds the system costs (solar PV panels, inverters, permitting, maintenance, etc.) over the system lifetime.</li> </ul>

<sup>28</sup> See, for instance, NREL’s page on renewable energy potential assessments: <https://www.nrel.gov/gis/re-potential.html>.

### Market Potential

- Market potential is the estimated achievable adoption of rooftop solar PV, which uses the economic potential as an input and accounts for regulations and policies to support rooftop solar PV adoption (e.g. streamlined permitting), demographic data, consumer behavior, and comparison to competition (e.g. grid supply).

## B.2 Application to Thermal Microgrids

**The technical potential** of thermal microgrids is the market size based on the technology's ability to meet end-customer energy needs. The technical potential for thermal microgrids can be divided into two parts: i) meeting the additional electricity load from electrification using carbon-free electricity, and ii) meeting the thermal needs of a site by converting the on-site building energy equipment from an existing fossil-fuel based system to a thermal microgrid leveraging advanced waste heat recovery. Regarding the former, using rough approximation, switching natural gas to electricity would result in an additional annual usage of 2,300 TWh<sup>29</sup>. This additional electricity load must be met by decarbonized electricity supply. The National Renewable Energy Laboratory (NREL) carried out an extensive GIS-based analysis to calculate the technical generation potential of several renewable energy technologies in the U.S. The result was hundreds of thousands of TWh of technical potential across the U.S.<sup>30</sup>. Although the study does not go so far as to consider technical feasibility of renewable energy integration, given a variety of renewable energy technologies were evaluated in the NREL study, with different hourly, daily and seasonal production profiles, and that the resultant technical potential is many orders of magnitude greater than the very rough anticipation of need from building electrification, one can safely assume there is sufficient renewable energy generation technical potential to accommodate electrification of the building sector, whether by districts or by a building-level approach. This general conclusion is consistent with regional and national decarbonization studies, all of which indicate that decarbonization is not limited by technical potential of clean energy supply<sup>31</sup>.

Given the above result, the technical potential is limited by feasibility of deploying the thermal network and the potential for renewable or waste heat recovery. Technical potential for the technology can be expressed in terms of system capacity in gigawatts thermal equivalent to meet the thermal needs of the study region, or for district heating potential exclusively, petajoules. A rigorous technical potential assessment would account for technical performance and limitations of on-site energy efficiency measures, thermal storage technologies, central and distributed heat recovery equipment, and

<sup>29</sup> Annual U.S. natural gas usage in 2016 in the commercial and residential sectors totaled 7,450,000 million cubic feet (U.S. EIA). Using the 2016 annual average heat content of natural gas of 1,037 BTU per cubic foot (U.S. EIA), this equates to approximately 7,700 million MMBTU. As an approximation, we assume all natural gas used in the residential and commercial sectors is used for space and water heating. Using rough approximation, switching natural gas to electricity would result in an additional annual usage of 2,300 TWh, using 3,412 BTU per kWh and assuming the appliance efficiency of each are equivalent. For reference, annual U.S. electricity sales in 2016 totaled 3,762 TWh.

<sup>30</sup> A. Lopez et al., U.S. Renewable Energy Technical Potentials: A GIS-Based Analysis, NREL/TP-6A20-51946, July 2012.

<sup>31</sup> See footnote 2.

topological or system constraints of the heating and cooling networks. Carrying out a calculation of the technical potential would incorporate the following steps<sup>32</sup>.

1. Select regions where the density of thermal load exceeds a specified threshold that makes thermal microgrids – and the development of a thermal network in a district energy system more generally – viable. As mentioned above, a region may be suitable for district energy if the heating load density is at least 0.93 kWh per square foot or the linear heat demand is at least 9,146 kWh per foot<sup>33</sup>. This can be used as a floor for load density in the technical potential assessment. In all other regions with insufficient thermal density, building-level electrification is a more suitable decarbonization pathway.
2. Model the hourly heating and cooling needs of the collection of buildings within each region that has sufficiently high thermal density. Thanks in part to the Open Government movement, an increasing amount of data is published by cities and states, including GIS data sets of land zoning (e.g. residential, commercial) and building information (e.g. number of floors, square footage, age). These data can be combined with other data sources (e.g. weather, census data, satellite imagery) and advanced analytics such as machine learning algorithms to model thermal loads quickly across large potential markets.
3. Estimate thermal microgrid potential in terms of megawatts capacity thermal equivalent needed to meet thermal loads of each region, calculated taking into consideration the overlap in heating and cooling loads; ground-, water-, and air-source heat recovery opportunities; hot and cold thermal storage; and, advanced analytics and controls. If a site has multiple thermal requirements (i.e. chilled and hot water), the thermal microgrid can be sized to meet the largest of the loads. This results in the total technical potential.

The technical potential is a necessary input for estimating a realistically achievable market size.

**Economic and market potential** builds on the technical potential by taking into account all other considerations to reach an ultimate estimated market size. Economic potential includes costs and benefits of deploying technically feasible systems. As mentioned previously, a district energy approach is generally economically advantageous if the cost savings from centralized versus building-level energy equipment is larger than the substantial costs of developing the thermal network. Furthermore, the cost-effectiveness of the distribution network is dependent upon the thermal density of customer demand, where the denser the load, the more cost-effective the service. Inputs for estimating the economic potential would include all the cost categories identified in section 3 over the system lifetime, which are compared to a baseline system design to determine cost-effectiveness. A comprehensive study of the potential of thermal microgrids in the U.S. is beyond the scope of this white paper, but the subject of ongoing R&D activity.

---

<sup>32</sup> See the following reference, for instance, for a technical potential study of district heating in the U.S.: Gils, H.C., et.al. “GIS-Based Assessment of the District Heating Potential in the USA.” *Energy* 58 (2013): 318–29

<sup>33</sup> District Heating and Cooling, Frederiksen and Werner (2013).

## **BENCHMARKING STUDY**

Attached is the Benchmarking Study dated August 2021 prepared in support of the Energy Master Plan.

**APPENDIX F**



# **Foothill-De Anza Community College District ENERGY BENCHMARKING STUDY**

**August 2021**

**Prepared for the  
Foothill-De Anza Community College District  
Energy and Sustainability Advisory Committee (ESAC)**

**Prepared by  
Sullivan Consulting, LLC**



# Table of Contents

Summary.....	2
Energy Usage at each Campus .....	2
<i>Foothill College</i> .....	3
<i>De Anza College</i> .....	3
<i>Sunnyvale Center</i> .....	4
<i>Green Power</i> .....	5
Greenhouse Gas Emissions .....	6
<i>Avoided GHG Emissions</i> .....	7
Energy Performance.....	8
<i>Benchmarking</i> .....	9
<i>DGS ZNE Target EUI</i> .....	10
Conclusions and Recommendations.....	11
Appendices .....	12
Appendix A - Foothill College Monthly Energy Usage 2018-2019 .....	12
Appendix B - De Anza College Monthly Energy Usage 2018-2019.....	12
Appendix C - Sunnyvale Center Monthly Energy Usage 2018-2019 .....	12

## Summary

Sullivan Consulting, LLC, prepared this Energy Benchmarking Study on behalf of the Foothill-De Anza Community College District Energy and Sustainability Advisory Committee (ESAC) to support developing an Energy Master Plan (EMP) for the district. The district consists of two college campuses and one educational center: Foothill College and De Anza College, and the Foothill College Sunnyvale Center. Sullivan Consulting utilized the US EPA Energy Star<sup>®</sup> Portfolio Manager software to perform the benchmarking process with results for each site compared to national average energy usage for university and colleges and California Community College energy usage data. Benchmarking metrics included annual energy usage (kBtu/hour), greenhouse gas (GHG) Emissions (metric tons CO<sub>2</sub>e/hour), Energy Use Intensity per campus gross square footage (kBtu/GSF), and GHG Emissions Intensity (metric tons CO<sub>2</sub>e /GSF).

The energy benchmarking results are detailed in the following pages of this report and include both tabular and graphical representations of district energy performance. This effort is a starting point for energy planning by identifying relative energy performance at the campus level. More detailed energy benchmarking at the whole building level on the campuses will be recommend in the Energy Master Plan. The study concluded that Foothill-De Anza district energy performance is significantly better than the national median for colleges and universities and the California Community College system-wide median. These results demonstrate that the district's past energy and sustainability activities have successfully reduced energy use and GHG emissions over time. However, new California regulations for energy efficiency, renewable energy, and carbon reduction will require that the district do even more to achieve these goals. The data and results of the Benchmarking Study will serve as a valuable guide to the district for these efforts.

## Energy Usage at each Campus

Monthly energy usage measured in kilowatt-hours (kWh) for grid purchased electricity and solar photovoltaic (PV) electricity generated on-site and therms for utility-supplied natural gas are tracked in the district Gridium Energy Information System (EIS). Sullivan Consulting uploaded the usage data to the EPA Portfolio Manager software account for each site. EPA Portfolio Manager provides the benchmarking tools and analysis features for the study. Energy usage and generation units are converted to thousand British Thermal Units per hour (kBtu/hr) to allow an apples-to-apples comparison of energy use across fuel sources. Since on-site classes and employee attendance were suspended due to COVID-19 in 2020 and 2021, resulting in low energy use years, the calendar years 2018 and 2019 were selected as the baseline years for benchmarking purposes.

The monthly energy usage at each campus for 2018 and 2019 are described graphically in the figures below. Data tables of monthly energy use are included in the Appendices.

### Foothill College

Foothill College is a full-service college campus located in Los Altos Hills and was initially constructed in 1958. The campus sits on 128 acres with 63 buildings totaling 623,670 gross square feet. As detailed in Figure 1, most of Foothill College's energy usage is natural gas. The natural gas usage is due to a central plant cogeneration system and natural gas-fired hot water boilers used for space heating (HVAC). This energy usage peaks in the winter months due to the heating load. This gas usage is problematic to achieving the district's goals for carbon and GHG emissions reductions. A recommendation of the Energy Master Plan will be to perform an Electrification Study and a Thermal Storage Analysis utilizing electric heat pumps for hot water production to reduce or eliminate natural gas use.

Figure 1 - Foothill College Monthly Energy Usage (kBtu/hr), 2018-2019

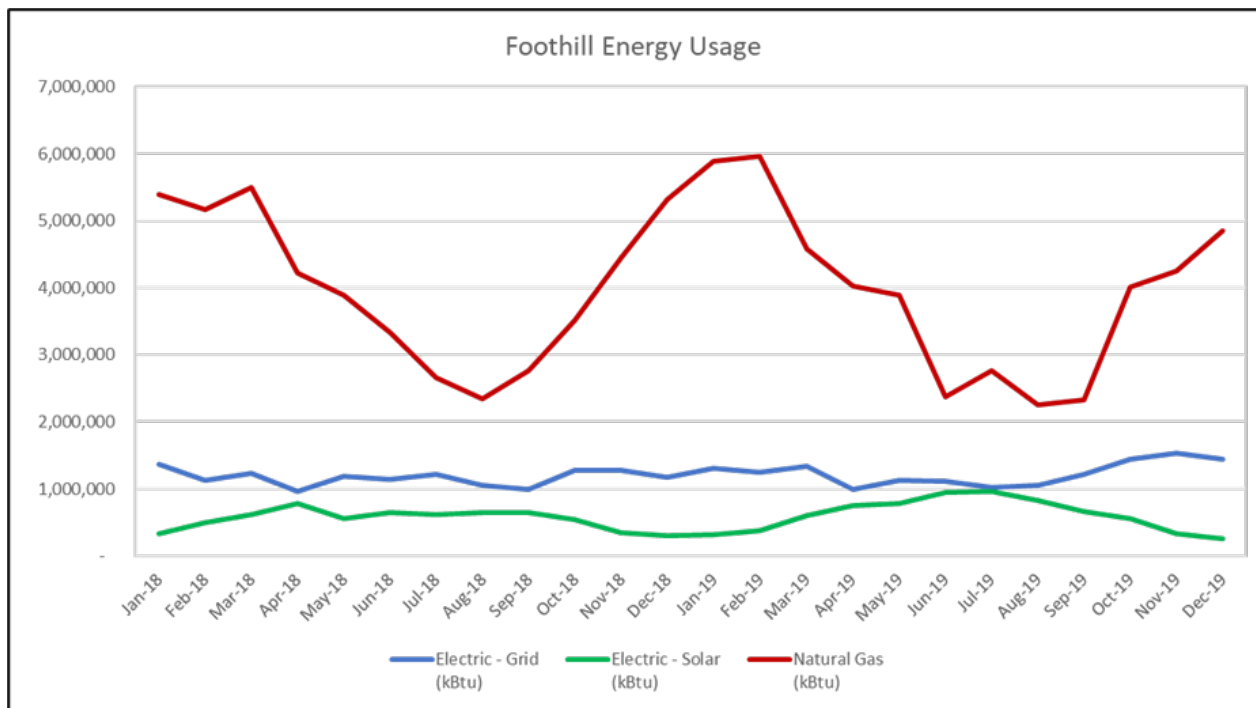

In addition, the figure above illustrates the relationship between grid-purchased electricity to on-site generated solar photovoltaic (PV) electricity. The district has installed 1.5 megawatts (MW) of solar PV on the campus which appears to be appropriately sized for the total campus electrical load. However, additional solar PV will be evaluated in a feasibility study proposed for the Energy Master Plan.

### De Anza College

De Anza College is a full-service college campus located in Cupertino with original construction in 1967. The campus is built on 112 acres with 74 buildings totaling 1,480,137 gross square feet. As detailed in Figure 2, as with Foothill, most energy usage at De Anza College is natural gas. This is primarily due to the cogeneration pool heating systems and hot water heating natural gas-fired boilers.

As described above, the replacement of the natural gas systems should be evaluated through the Electrification Study conducted during the Energy Master Plan Implementation. The grid purchased and PV generated electricity relationship looks appropriate, but the planned PV feasibility study during the EMP implementation will determine if additional PV is warranted. The district would like to maximize PV at the campuses for economic reasons and to reduce GHG emissions.

Figure 2 – De Anza College Monthly Energy Usage (kBtu/hr), 2018-2019

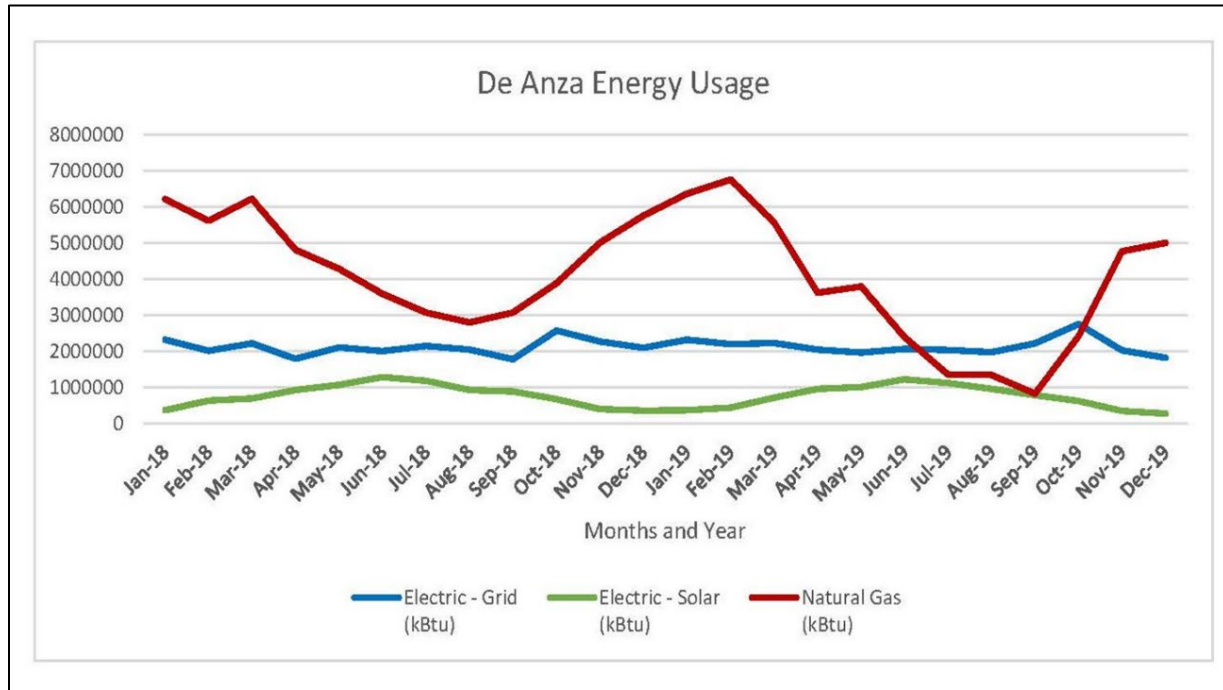

### Sunnyvale Center

The Foothill College Sunnyvale Center serves as a regional educational center and workforce resource advancing the region's economic well-being by serving employer training needs, developing a quality workforce, and serving as a key player in local and regional workforce development initiatives. The Sunnyvale Center is a single-building campus located at the former Onizuka Air Force Station site in Sunnyvale. It is a two-story, 46,882 sq. ft. facility constructed in 2016 as a state-of-the-art LEED Platinum building.

As indicated in Figure 3, the Sunnyvale Center has a very low natural gas load, and its energy usage is primarily electric. The electricity is all grid-purchased from Silicon Valley Clean Energy and is 100% renewable and carbon-free. While this would meet the district's GHG reduction goals, the proposed photovoltaic generation study from the Energy Master Plan implementation will evaluate PV at the site as an economic opportunity.

Figure 3 – Sunnyvale Center Monthly Energy Usage (kBtu/hr), 2018-2019

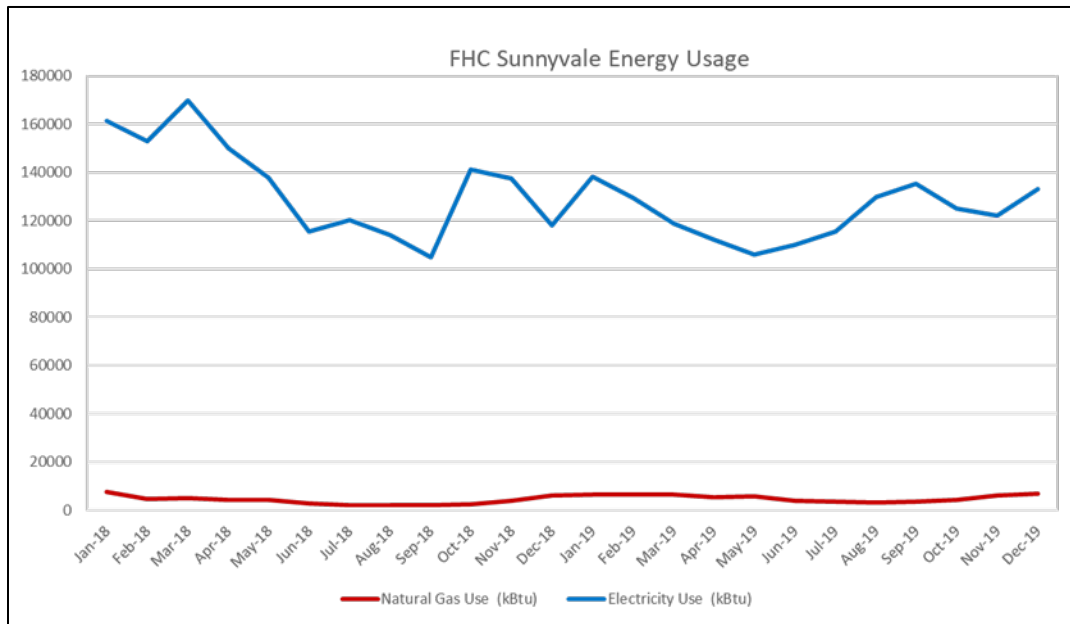

*Green Power*

Green power is defined as renewable energy sources and specific clean energy technologies that emit fewer GHG emissions relative to other sources of energy that supply the electric grid. Green power can be provided directly from an on-site renewable system or purchased from the utility or independent green power supplier. The customer must retain the Renewable Energy Certificates (RECs) for electrical power to be considered green. Onsite green power includes solar PV or wind power. Offsite Green power sources in Portfolio Manager include solar, wind, geothermal, biogas (landfill gas), biomass, and small hydropower. The offsite green power illustrated is based on the utility power content labels. The table below details the green power content for the district for the calendar year 2019.

Table 1 – Green Power (kWh), 2019

Property Name	Year Ending	Electricity Use - Grid Purchase (kWh)	Green Power - Onsite (kWh)	Green Power - Offsite (kWh)	Percent of Electricity that is Green Power
De Anza College	12/31/2019	7,529,923	2,596,570	2,033,079	46
Foothill College	12/31/2019	4,356,115	2,166,201	1,176,152	51
FHC Sunnyvale Center	12/31/2019	432,218	N/A	432,218	100

## Greenhouse Gas Emissions

Greenhouse gas (GHG) Emissions include carbon dioxide (CO<sub>2</sub>), methane (CH<sub>4</sub>), and nitrous oxide (N<sub>2</sub>O) gases released into the atmosphere as a result of energy consumption at a property. GHG emissions are expressed in carbon dioxide equivalent (CO<sub>2</sub>e), a universal measure that combines each greenhouse gas's quantity and global warming potential. Emissions are reported in four categories, as follows:

- **Direct Emissions** are emissions associated with on-site fuel combustion (e.g., natural gas or fuel oil).
- **Indirect Emissions** are emissions associated with electricity purchases, district steam, district hot water, or district chilled water. These emissions occur at the facility's central plant, but they result from the property's energy consumption and contribute to the overall GHG footprint.
- **Biomass Emissions** are emissions associated with biogenic fuels such as wood or biogas (captured methane).
- **Total Emissions** are the total sum of all emissions.

The GHG emissions at all three campuses are in the Direct and Indirect categories as there is no biomass generation in the district. In addition, the emissions calculated are related to energy generation and usage only and do not include GHG emissions from vehicles, transportation, or commuting.

Table 2 below describes the total GHG emissions for each campus for the calendar year 2019. The district will use this as a baseline for GHG emissions reduction strategies.

**Table 2 – Total GHG Emissions, 2019**

Property Name	Year Ending	Total GHG Emissions (Metric Tons CO <sub>2</sub> e)
De Anza College	12/31/2019	4053.2
Foothill College	12/31/2019	3491.9
FHC Sunnyvale Center	12/31/2019	101.1

Figure 4 below provides a graphical comparison of all three campuses for 2019 Total GHG emissions. This clearly illustrates the emission magnitude of each campus.

Figure 4 – Total GHG Emissions Comparison, 2019

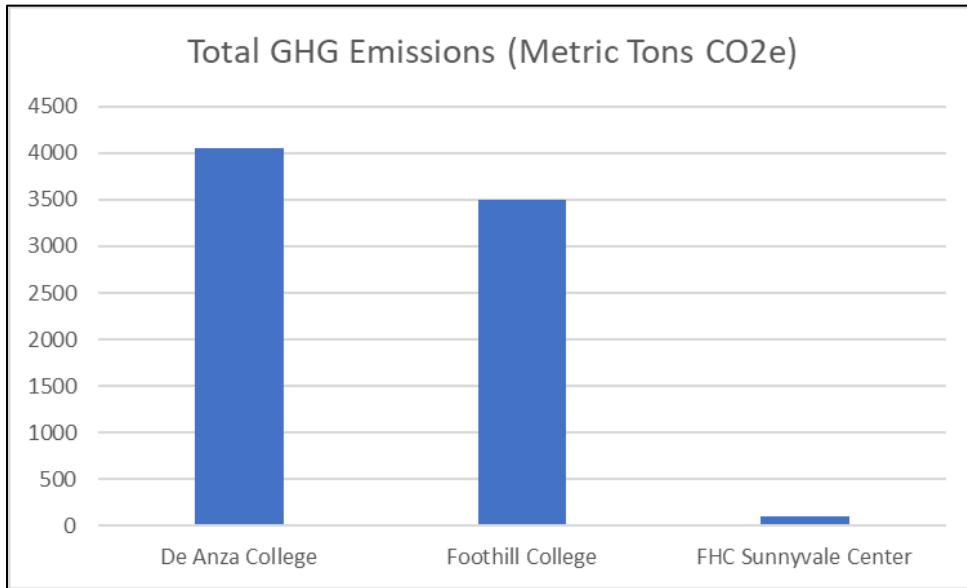

*Avoided GHG Emissions*

Avoided GHG Emissions are the emissions benefits associated with green power use. Avoided emissions may be either *on-site* or *offsite*.

- Onsite Avoided Emissions are the emissions benefits of the on-site renewable energy system (when the Renewable Energy Certificates (RECs) have been retained) due to the reduction in grid-supplied electricity.
- Offsite Avoided Emissions occur with the purchase of grid green power (which comes with RECs) from a utility or an independent supplier.

Foothill-De Anza district benefits from Onsite Avoided Emissions due to the significant amount of solar PV energy generated on-site. In addition, the district also benefits from Offsite Avoided Emissions based on the renewable energy content of grid purchased electricity from Constellation Energy for Foothill and De Anza campuses (27% renewable content) and Silicon Valley Clean Energy at the Sunnyvale Center (100% renewable content).

Table 3 below details the Total and Avoided Emissions for the three campuses for 2019.

**Table 3 – Total and Avoided Emissions, 2019**

Property Name	Year Ending	Total GHG Emissions (Metric Tons CO2e)	Avoided Emissions - Onsite Green Power (Metric Tons CO2e)	Avoided Emissions - Offsite Green Power (Metric Tons CO2e)
De Anza College	12/31/2019	4,053.2	1,098.2	859.9
Foothill College	12/31/2019	3,491.9	916.2	497.4
FHC Sunnyvale Center	12/31/2019	101.1	N/A	182.8

## Energy Performance

The energy performance metric used to benchmark the district facilities is Energy Use Intensity (EUI). EUI is the energy use per square foot at a property. EUI enables the comparison of energy usage of different properties or individual buildings and measures relative energy efficiency.

EPA Portfolio Manager uses two different EUI categories for benchmarking: Site EUI and Source EUI.

- Site EUI is based on the annual amount of all the energy consumed on-site, regardless of the source. It includes energy purchased from the grid and renewable energy generated and consumed on-site such as solar and wind (excess renewable energy generated on-site and exported to the utility is excluded from site energy use).
- Source energy is the total amount of raw fuel that is required to operate the property. In addition to what the property consumes on-site, source energy includes losses during the generation, transmission, and distribution, thereby enabling a complete assessment of energy consumption resulting from building operations. For this reason, Source EUI is the best way to quantify the energy performance of buildings. The State of California Department of General Services (DGS) has adopted source energy and Source EUI to evaluate state building energy performance. Therefore, Source EUI was used in this Benchmarking Study to understand the complete energy impact of the facilities and compare the district's energy performance to other similar facilities.

The Energy Performance of the three district campuses/sites is described in Table 4 below. The data is based on calendar year 2019 energy usage.



Table 4 – Energy Performance (EUI) 2019

Property Name	Site Energy Use (kBtu)	Source Energy Use (kBtu)	Site EUI (kBtu/ft <sup>2</sup> )	Source EUI (kBtu/ft <sup>2</sup> )	Total GHG Emissions (Metric Tons CO <sub>2</sub> e)	Total GHG Emissions Intensity (kgCO <sub>2</sub> e/ft <sup>2</sup> )
De Anza College	78,795,293	127,253,259	82.4	133.1	4,053	4.2
Foothill College	69,445,147	98,558,219	96.8	137.4	3,492	4.9
FHC Sunnyvale Center	1,537,328	4,194,968	32.7	89.3	101	2.2

Source Energy and Source EUI have been highlighted in the figure. These metrics will be used to compare the district energy use of other similar facilities and campuses.

### Benchmarking

The district EUI data for 2019 was benchmarked against the national median Source EUI for Colleges/University buildings (data from Portfolio Manager) and the median Source EUI of the California Community College system. The median EUI of the CCC system was determined based on the annual energy usage reports submitted to the CCC Chancellors Office by the districts. The latest data available was for the Fiscal Year 2017-2018.

Figure 5 – Foothill and De Anza Benchmarking Data, 2019

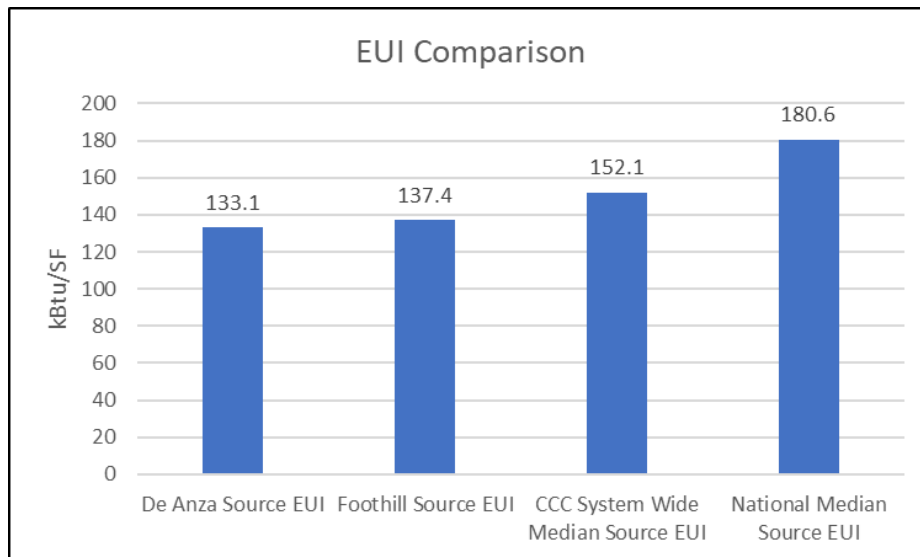

Note: System-wide data is FY 17-18, with 61 of 72 districts reporting.

Figure 5 illustrates the benchmarked data for Foothill and De Anza colleges. The figure shows that both Foothill College and De Anza college have significantly lower EUI than the national median EUI of 180.6 and the CCC system-wide median of 152.1.

It was considered inappropriate to benchmark the Sunnyvale Center to a college/university campus use. It was determined that the center would be benchmarked against the national median for an Adult Education building use. While this is the national median and not the ideal benchmark, it is still a relative energy performance indicator. The national median Source EUI is 110.4, while the Sunnyvale Center outperforms this with a Source EUI of 89.3. Figure 6 illustrates the benchmarked data for Sunnyvale Center

Figure 6 – Sunnyvale Center Benchmarking Data

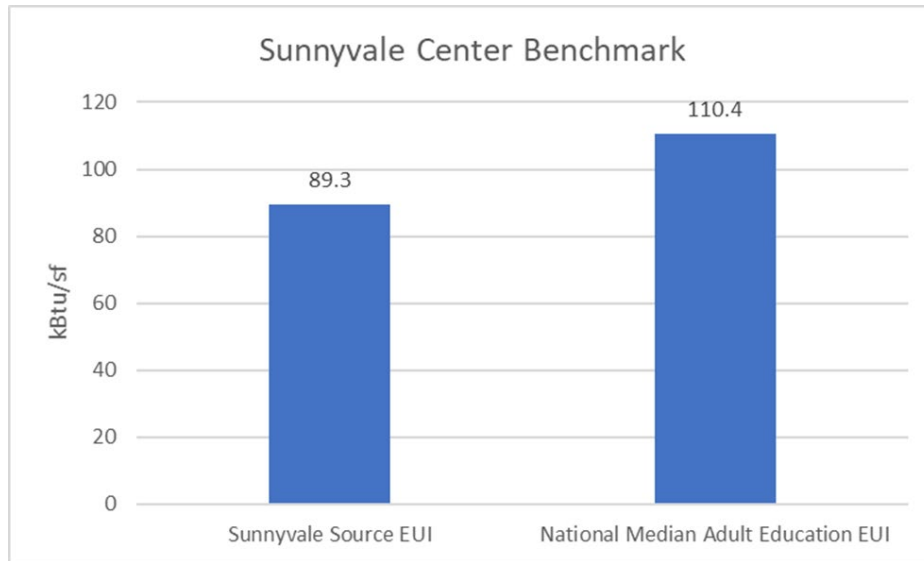

*DGS ZNE Target EUI*

The California Department of General Services has developed guidelines and targets for state buildings to achieve Zero Net Energy (ZNE). They have set a target EUI for each climate zone to assist state agencies in benchmarking their facilities to the ZNE standard. All three district campuses are in California Climate Zone 4, with a ZNE Source EUI target of 95 kBtu/SF. Sunnyvale Center meets this target with a Source EUI of 89.3. Both Foothill and De Anza campuses will likely need to improve energy efficiency, drastically reduce or eliminate natural gas usage, and install additional renewable energy to meet the ZNE target.

---

## Conclusions and Recommendations

The conclusions and recommendations from the Benchmarking Study are as follows:

- District Energy Performance is significantly better than the national median as well as the California Community College median for the same building/campus type
- The deployment of large-scale solar PV generation at Foothill and De Anza significantly improves GHG emissions performance
- The LEED Platinum rated Sunnyvale Center is highly energy-efficient and surpasses the DGS standard for ZNE EUI targets. It also uses 100% renewable content grid electricity, with less than 110 tons of annual CO<sub>2</sub>e emissions.
- Both Foothill and De Anza campuses will need to improve energy efficiency, add additional on-site and offsite renewable energy, and reduce natural gas usage to meet the ZNE target.
- Additional onsite solar PV is needed for electrification of HVAC projects, and additional electric vehicle supply equipment (EVSE)
- It will be a significant challenge for the electrification of natural gas usage at all three district sites to achieve the carbon reduction goals of the Energy Master Plan
- Building-level Benchmarking at both Foothill and De Anza campuses would be valuable in developing improvement strategies and should be considered as a recommendation in the Energy Master Plan

The Energy Usage Data Tables for 2018 and 2019 are included in the Appendices of this report.

## Appendices

Appendix A - Foothill College Monthly Energy Usage 2018-2019

Appendix B - De Anza College Monthly Energy Usage 2018-2019

Appendix C - Sunnyvale Center Monthly Energy Usage 2018-2019

## APPENDIX F

### Energy Use By Calendar Month (Not Weather Normalized)

Property: Foothill College (ID 15226581)

Calendar Year: 2018-2019

Month	Electric - Grid (kBtu)	Electric - Solar (kBtu)	Natural Gas (kBtu)
Jan-18	1,375,012	325,672	5,389,200
Feb-18	1,134,862	504,259	5,161,200
Mar-18	1,227,133	613,447	5,490,499
Apr-18	964,893	776,745	4,225,100
May-18	1,183,848	564,335	3,894,100
Jun-18	1,143,269	649,038	3,327,500
Jul-18	1,221,080	610,468	2,657,800
Aug-18	1,048,538	647,598	2,337,200
Sep-18	991,790	655,046	2,762,100
Oct-18	1,280,506	547,646	3,508,200
Nov-18	1,284,461	340,309	4,442,600
Dec-18	1,172,241	306,411	5,309,600
Jan-19	1,314,217	310,976	5,881,599
Feb-19	1,253,524	380,602	5,966,501
Mar-19	1,339,336	608,001	4,576,700
Apr-19	991,029	753,383	4,028,100

## APPENDIX F

### Energy Use By Calendar Month (Not Weather Normalized)

Property: Foothill College (ID 15226581)

Calendar Year: 2018-2019

Month	Electric - Grid (kBtu)	Electric - Solar (kBtu)	Natural Gas (kBtu)
May-19	1,123,834	775,735	3,895,100
Jun-19	1,113,332	954,954	2,377,000
Jul-19	1,027,684	962,713	2,770,100
Aug-19	1,055,212	828,413	2,257,100
Sep-19	1,222,919	668,486	2,327,900
Oct-19	1,448,329	562,444	4,009,000
Nov-19	1,537,754	334,618	4,257,001
Dec-19	1,435,896	250,751	4,844,900
<b>Total</b>	<b>28,890,700</b>	<b>13,932,052</b>	<b>95,696,102</b>

## APPENDIX F

### Energy Use By Calendar Month (Not Weather Normalized)

Property: De Anza College (ID 15178421)

Calendar Years: 2018-2019

Month	Electric - Grid (kBtu)	Electric - Solar (kBtu)	Natural Gas (kBtu)
Jan-18	2,322,220.9	371,020.9	6,210,999.4
Feb-18	2,013,649.7	636,320.9	5,614,800.5
Mar-18	2,223,689.2	698,433.0	6,224,499.3
Apr-18	1,798,871.1	933,239.9	4,817,500.2
May-18	2,112,911.6	1,071,381.5	4,283,800.1
Jun-18	2,010,132.0	1,288,589.7	3,592,500.0
Jul-18	2,152,262.4	1,181,630.2	3,072,300.0
Aug-18	2,049,127.9	926,199.6	2,799,899.9
Sep-18	1,783,268.1	887,780.2	3,072,499.8
Oct-18	2,579,963.2	677,546.5	3,887,699.8
Nov-18	2,267,536.8	402,305.5	5,020,800.9
Dec-18	2,097,182.2	359,024.3	5,759,999.3
Jan-19	2,319,658.4	371,143.7	6,372,499.8
Feb-19	2,205,390.6	447,531.6	6,756,999.2

## APPENDIX F

### Energy Use By Calendar Month (Not Weather Normalized)

Property: De Anza College (ID 15178421)

Calendar Years: 2018-2019

Month	Electric - Grid (kBtu)	Electric - Solar (kBtu)	Natural Gas (kBtu)
Mar-19	2,229,943.5	712,244.8	5,576,898.5
Apr-19	2,049,472.5	956,881.7	3,619,500.0
May-19	1,972,173.5	1,010,272.7	3,794,000.1
Jun-19	2,064,642.0	1,225,535.9	2,389,300.2
Jul-19	2,036,384.1	1,124,274.2	1,358,699.9
Aug-19	1,979,219.2	964,152.5	1,348,400.2
Sep-19	2,224,054.2	785,589.1	829,800.1
Oct-19	2,756,674.1	629,640.3	2,426,600.1
Nov-19	2,031,344.4	353,687.1	4,769,298.9
Dec-19	1,823,144.1	278,542.0	5,001,700.3
<b>Total</b>	<b>51,102,915.7</b>	<b>18,292,967.5</b>	<b>98,600,996.3</b>



## APPENDIX F

### Energy Use by Calendar Month

Property: Foothill Sunnyvale Center

Calendar Year: 2018-2019

Month	Natural Gas Use (kBtu)	Electricity Use (kBtu)
Jan-18	7,570.0	161,469.5
Feb-18	4,820.0	152,939.5
Mar-18	5,010.0	169,893.7
Apr-18	4,160.0	150,083.6
May-18	4,400.0	137,715.1
Jun-18	2,830.0	115,417.7
Jul-18	2,320.0	120,075.1
Aug-18	2,220.0	113,984.7
Sep-18	2,000.0	104,901.9
Oct-18	2,630.0	141,140.8
Nov-18	3,800.0	137,616.2
Dec-18	6,300.0	118,017.7
Jan-19	6,690.0	138,363.4

## APPENDIX F

### Energy Use by Calendar Month

Property: Foothill Sunnyvale Center

Calendar Year: 2018-2019

Month	Natural Gas Use (kBtu)	Electricity Use (kBtu)
Feb-19	6,680.0	129,308.0
Mar-19	6,370.0	118,621.6
Apr-19	5,280.0	112,278.7
May-19	5,700.0	105,840.2
Jun-19	3,850.0	109,832.3
Jul-19	3,780.0	115,421.1
Aug-19	3,390.0	129,939.2
Sep-19	3,480.0	135,159.6
Oct-19	4,310.0	125,032.7
Nov-19	6,100.0	122,006.3
Dec-19	6,970.0	132,924.7
<b>Total</b>	<b>110,660.0</b>	<b>3,097,983.3</b>

## GLOSSARY OF TERMS

### Acronyms

<b>AASHE</b>	Association for the Advancement of Sustainability in Higher Education
<b>AB</b>	Assembly Bill
<b>ACBO</b>	Association of Chief Business Officers
<b>ASHRAE</b>	American Society of Heating, Refrigerating and Air-Conditioning Engineers
<b>BES</b>	Battery Energy Storage
<b>BMS</b>	Building Management System (also known as Energy Management System)
<b>BOG</b>	Board of Governors
<b>BTU</b>	British Thermal Unit, a unit of energy measurement
<b>CAP</b>	Climate Action Plan
<b>CARB</b>	California Air Resources Board
<b>CCA</b>	Community Choice Aggregation
<b>CCC</b>	California Community College
<b>CCD</b>	Community College District
<b>C&amp;D</b>	Construction & Demolition
<b>CCFC</b>	Community Colleges Facilities Coalition
<b>CEC</b>	California Energy Commission
<b>CEQA</b>	California Environmental Quality Act
<b>CH<sub>4</sub></b>	Methane (a greenhouse gas)
<b>CO<sub>2</sub></b>	Carbon Dioxide (a greenhouse gas)
<b>CO<sub>2e</sub></b>	Carbon Dioxide equivalent
<b>CPUC</b>	California Public Utilities Commission
<b>EIS</b>	Energy Information System
<b>EMP</b>	Energy Master Plan
<b>EMS</b>	Energy Management System (also known as Building Management System)
<b>EO</b>	Executive Order
<b>EPA</b>	Environmental Protection Agency
<b>EPC</b>	Energy Performance Contract
<b>ESAC</b>	Energy and Sustainability Advisory Committee
<b>ESCO</b>	Energy Services Company
<b>EUI</b>	Energy Use Intensity
<b>EV</b>	Electric Vehicle
<b>DR</b>	Demand Response
<b>FEMP</b>	Federal Energy Management Program
<b>FCCC</b>	Foundation for California Community Colleges
<b>FMP</b>	Facility Master Plan
<b>GHG</b>	Greenhouse Gas
<b>HFCs</b>	Hydrofluorocarbons (a greenhouse gas)
<b>HVAC</b>	Heating, Ventilation, and Air Conditioning
<b>IOU</b>	Investor-Owned Utility
<b>IPCC</b>	Intergovernmental Panel on Climate Change
<b>IRR</b>	Internal Rate of Return
<b>kWh</b>	Kilowatt-hour

<b>LCCA</b>	Life Cycle Cost Analysis
<b>LCFS</b>	Low Carbon Fuel Standard
<b>LEED</b>	Leadership in Energy and Environmental Design
<b>MBCx</b>	Monitoring Based Commissioning
<b>MWh</b>	Megawatt-hour
<b>NGOM</b>	Net Generation Output Meter
<b>N<sub>2</sub>O</b>	Nitrous Oxide (a greenhouse gas)
<b>NPV</b>	Net Present Value
<b>O&amp;M</b>	Operations and Maintenance
<b>OBF</b>	On-Bill Financing
<b>PFCs</b>	Perfluorocarbons (a greenhouse gas)
<b>PG&amp;E</b>	Pacific Gas & Electric
<b>PPA</b>	Power Purchase Agreement
<b>PSPS</b>	Public Safety Power Shutoffs
<b>PV</b>	Photovoltaic (Solar Panel)
<b>RCx</b>	Retro commissioning
<b>REC</b>	Renewable Energy Credit or Renewable Energy Certificate
<b>RFP</b>	Request for Proposal
<b>ROI</b>	Return on Investment
<b>SB</b>	Senate Bill
<b>SESI</b>	Stanford Energy Systems Innovation
<b>SF<sub>6</sub></b>	Sulfur Hexafluoride (a greenhouse gas)
<b>SPB or SPP</b>	Simple Payback Period
<b>STARS</b>	Sustainability Tracking Assessment and Reporting System
<b>Therms</b>	Natural Gas Energy Measurement
<b>T&amp;D</b>	Transmission and Distribution
<b>TES</b>	Thermal Energy Storage
<b>TOTEM</b>	Tool for Optimization of Thermal and Electric Microgrids
<b>VMT</b>	Vehicle Miles Traveled
<b>WRI</b>	World Resources Institute
<b>ZNE</b>	Zero Net Energy

## GHG Emissions Definitions

**Scope 1 Emissions** - all direct emissions from sources owned and controlled by the college, such as carbon dioxide released by burning natural gas on site.

**Scope 2 Emissions** – all indirect emissions from consumption of purchased energy utilities, such as electricity, heat, or steam.

**Scope 3 Emissions** - all indirect emissions not covered by Scopes 1 and 2 and includes emissions from student and staff commuting.